

COMMANDER PHONE

OFFICE T46G



USER GUIDE

> Please read carefully before use.
Applies to firmware version 71 or later.

COMMANDER

About This Guide

Thank you for choosing the Commander Office T46G IP Phone, an ultra-elegant gigabit IP Phone which is exquisitely designed to provide business telephony features over an IP network.

This guide provides everything you need to quickly use your new phone. First, verify with your system administrator that the IP network is ready for phone configuration. Also be sure to read the Packaging Contents and Regulatory Notices sections in this guide before you set up and use the Commander Office T46G IP phone.

If this is your first time using the Commander Office T46G IP phone, we recommend that you first refer to the Quick Installation Guide and Quick Reference Guide, available online:

<http://commander.com/phone/commander-phone/resource-centre>

This guide may contain references to features that are supported by the handset however may not be available with the specific Commander Phone service or plan that you have decided upon.

In This Guide

Topics provided in this guide include:

- Chapter 1 [Overview](#)
- Chapter 2 [Getting Started](#)
- Chapter 3 [Customising Your Phone](#)
- Chapter 4 [Basic Call Features](#)
- Chapter 5 [Advanced Phone Features](#)

Table of Contents

About This Guide vi

In This Guidevi

Table of Contents vii

Overview..... 1

Hardware Component Instructions1
Icon Instructions.....3
LED Instructions5
User Interfaces6
 Phone User Interface6
 Web User Interface.....6
Documentation8

Getting Started 9

Packaging Contents9
Phone Installation.....11
Phone Initialization14
Phone Status14
Basic Network Settings15
Idle Screen.....15

Customising Your Phone..... 16

General Settings16
 Wallpaper.....16
 Backlight17
 Contrast18
 Language19
 Time & Date20
 Keypad Lock.....22
Audio Settings26
 Volume.....26
 Ring Tones27
Contact Management29
 Directory.....29

Local Directory.....	30
Blacklist	43
Remote Phone Book.....	45
Call History Management	47
System Customisations	48
Headset Use	48
Bluetooth Headset	50
DSS Keys	55
Emergency Number	66
Hotline	67

Basic Call Features..... 69

Placing Calls.....	69
Answering Calls	71
Ending Calls.....	72
Redialing Numbers.....	73
Recent Call In Dialing.....	73
Auto Answer.....	74
Auto Redial.....	75
Call Completion	76
Call Return	78
Call Mute	78
Call Hold/Resume	79
Do Not Disturb (DND)	80
Call Forward.....	84
Call Transfer.....	91
Call Waiting.....	92
Conference.....	93
Local Conference	93
Network Conference	94
Call Park.....	96
Call Pickup.....	97
Anonymous Call	101
Anonymous Call Rejection.....	102

Advanced Phone Features 103

Busy Lamp Field (BLF)	103
Call Recording.....	106
Hot Desking	108
Intercom	110
Outgoing Intercom Calls	110
Incoming Intercom Calls	111
Multicast Paging.....	112

Sending RTP Stream.....	113
Receiving RTP Stream	115
Music on Hold	116
Automatic Call Distribution (ACD)	117
Messages	119
Short Message Service (SMS)	119
Voice Mail.....	122
Message Waiting Indicator (MWI).....	123
Troubleshooting.....	127
Regulatory Notices	134
Service Agreements	134
Limitations of Liability	134
Safety Instructions	134
Index.....	136

Overview

This chapter provides the overview of the Commander Office T46G IP phone. Topics include:

- [Hardware Component Instructions](#)
- [Icon Instructions](#)
- [LED Instructions](#)
- [User Interfaces](#)
- [Documentation](#)





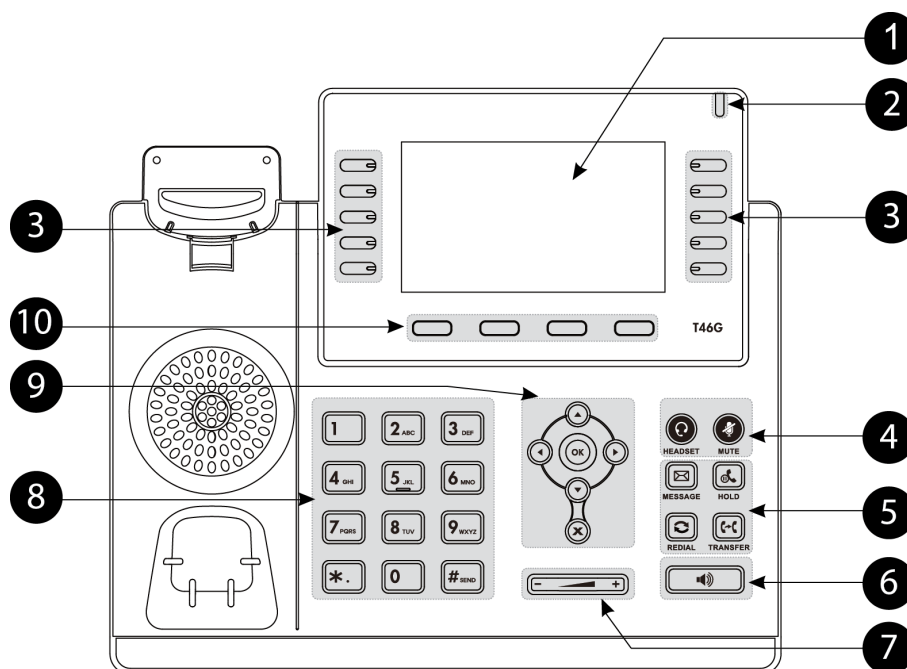

If you require additional information or assistance with your new phone, contact your system administrator.

Hardware Component Instructions

The main hardware components of the Commander Office T46G IP phone are the LCD screen and the keypad.





















Hardware component instructions of the Commander Office T46G IP phone are:

	Item	Description
①	LCD Screen	Shows information about calls, messages, soft keys, time, date and other relevant data: <ul style="list-style-type: none"> • Call information—caller ID, call duration • Icons (for example, ) • Missed call text or second incoming caller information • Prompt text (for example, "Saving file, please wait") • Time and date
②	Power Indicator LED	Indicates phone power and some feature statuses.
③	Line Keys	Use these keys to activate up to six accounts and assign various features.
④	HEADSET Key	Toggles and indicates the headset mode.
	MUTE Key	Toggles and indicates mute feature.
⑤	MESSAGE Key	Accesses voice messages.
	HOLD Key	Places a call on hold or resumes a held call.
	REDIAL Key	Redials a previously dialed number.
	TRANSFER Key	Transfers a call to another party.
⑥	Speakerphone Key	Toggles the hands-free speakerphone mode.
⑦	Volume Key	Adjusts the volume of the handset, headset, speaker, and ringer.
⑧	Keypad	Provides the digits, letters and special characters in context-sensitive applications.
⑨	   	Scroll through the displayed information.
		Confirms actions or answers incoming calls.
		Cancels actions or rejects incoming calls.
⑩	Soft Keys	Label automatically to identity their context-sensitive features.

Icon Instructions

Icons appearing on the LCD screen are described in the following table:

Icons	Description
	Network is unavailable
	Registered successfully
	Register failed
	Registering
	Hands-free speakerphone mode
	Handset mode
	Headset mode
	Multi-lingual lowercase letters input mode
	Multi-lingual uppercase letters input mode
	Alphanumeric input mode
	Numeric input mode
	Multi-lingual uppercase and lowercase letters input mode
	Voice Mail
	Text Message
	Auto Answer
	Do Not Disturb
	Call Forward
	Call Hold
	Call Mute

Icons	Description
	Ringer volume is 0
	Keypad Lock
	Received Calls
	Placed Calls
	Missed Calls
	Recording box is full
	A call cannot be recorded
	Recording starts successfully
	Recording cannot be started
	Recording cannot be stopped
	Bluetooth
	Bluetooth headset is both paired and connected
	Conference
	The contact icon
	The default caller photo

LED Instructions

Power Indicator LED

LED Status	Description
Solid red	The phone is initializing.
Fast flashing red	The phone is ringing.
Slow flashing red	The phone receives a text message or voice mail.
Off	The phone is powered off, powered on or idle.

Line key LED

LED Status	Description
Solid green	The line is seized. The line is in conversation.
Fast flashing green	The line receives an incoming call.
Slow flashing green	The call is placed on hold.
Off	The line is inactive.

Line key LED (configured as BLF key)

LED Status	Description
Solid red	The monitored user is busy.
Fast flashing red	The monitored user receives an incoming call.
Off	The monitored user is idle. The monitored user does not exist.

Line key LED (used as page switch key)

LED Status	Description
Solid red	There is a parked call on the line key of the non-current page.
Fast flashing green	The line receives an incoming call on the line key of the non-current page.
Fast flashing red	The monitored user receives an incoming call on the line key of the non-current page.
Off	The line keys are idle.

User Interfaces

Two ways to customise configuration of your Commander Office T46G IP phone:

- The user interface on the IP phone.
- The user interface in a web browser on your PC.

The hardware components keypad and LCD screen constitute the phone user interface, which allows you to execute all call operation tasks and basic configuration changes directly on the phone. In addition, you can use the web user interface to access all configuration settings. In many cases, it is possible to use either the phone user interface and/or the web user interface interchangeably. However, in some cases, it is only possible to use one or the other interface to operate the phone and change settings.

Phone User Interface

You can customise your phone by pressing the Menu soft key to access the phone user interface. The Advanced option is only accessible to the administrator, and the default administrator password is “admin” (case-sensitive). For more information on customizing your phone with the available options from the phone user interface, refer to [Customising Your Phone](#) on page 16.

Web User Interface

In addition to the phone user interface, you can also customise your phone via web user interface. In order to access the web user interface, you need to know the IP address of your new phone. To obtain the IP address, press the OK key on the phone. Enter the IP address (e.g., <http://192.168.0.10> or 192.168.0.10) in the address bar of web browser on your PC. The default user name and password are `yui_user` and `yui_user123` (both case sensitive).

The options you can use to customise the IP phone via phone user interface and/or via web user interface are listed in the following table (note: some of the items in the below table cannot be edited due to security restrictions in place to ensure your phone service continues to work):

Options	Phone User Interface	Web User Interface
Status	√	√
--IPv4		
--MAC		
--Firmware		
--Network		
--Phone		
--Accounts		
Basic Call Features		√
--Auto Answer	√	

--Auto Redial	√	
--Call Completion	√	
--Call Forward	√	
--Call Waiting	√	
--Call Park	√	
--Call Pickup	√	
--Call Return	√	
--Conference		
--Anonymous Call	√	
--Anonymous Call Rejection	√	
--DND	√	
Basic Phone Settings		
--Language	√	√
--Time & Date	√	√
--Administrator Password	√	√
--Ring Tones	√	√
--Contrast	√	
--Wallpaper	√	√
--Backlight	√	√
--Keypad Lock	√	√
--Phone Volume	√	
--Call History Management	√	
--Contact Management		√
--Local Directory	√	√
--Blacklist	√	√
--Remote Phone Book		√
--LDAP		√
--Dial Plan		√
--DSS Keys	√	√
--Key as Send	√	√
--Hotline	√	√
--Live Dialpad		√
--Emergency Number		√
Advanced Phone Features		
--BLF	√	
--Call Recording	√	
--Hot Desking	√	
--Intercom	√	
--Multicast Paging		
--Music on Hold		
--ACD	√	
--Messages	√	

√

SIP Account		√
--User Options		
--Register Status	√	
--Account Status	√	
--Label	√	
--Display Name	√	
--Register Name	√	
--User Name	√	
--Password	√	
--SIP Server 1/2	√	
--Server Option		
--Registrar Port		
--Outbound Status	√	
--Outbound Proxy	√	
--NAT Traversal		
--STUN Status	√	
--STUN Server	√	

Note

The table above lists most of the feature options. Please refer to the relevant sections for more information.

Documentation

The following table shows documentations available for the Commander Office T46G IP phone.

Name	Contents	Where found	Format/ Language
Quick Installation Guide	Basic setup of the phone	In the package	PDF/English
Quick Reference Guide	Basic call features and phone customizations	In the package	PDF/English
User Guide	Phone/Web user interface settings Basic call features and advanced phone features	Online in the Commander Phone Resource Centre	PDF/English

Note

You can also download the latest documentation online:
<http://commander.com/phone/commander-phone/resource-centre/>

Getting Started

This chapter provides the following basic installation instructions and information for obtaining the best performance with the Commander Office T46G IP phone. Topics include:

- [Packaging Contents](#)
- [Phone Installation](#)
- [Phone Initialization](#)
- [Phone Status](#)
- [Basic Network Settings](#)
- [Idle Screen](#)

If you require additional information or assistance with your new phone, contact your system administrator.

Packaging Contents

The following components are included in your Commander Office T46G IP phone package:

- Commander Office T46G IP Phone

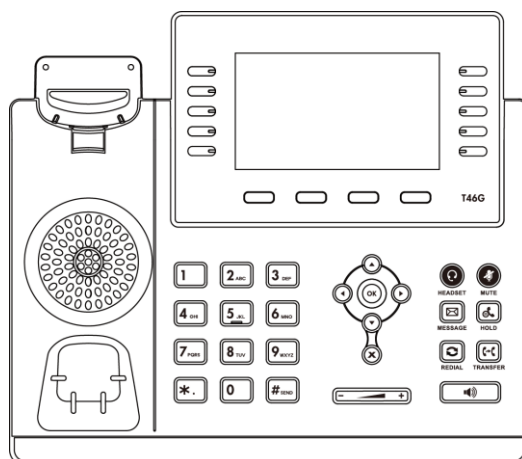

- Phone Stand

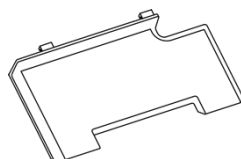

- Wall Mount Bracket (Optional)

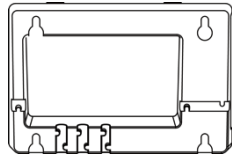

- Power Adapter (Optional)

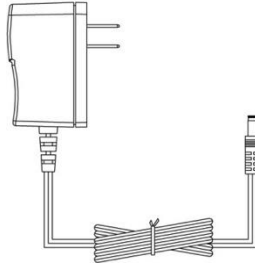

- Handset & Handset Cord

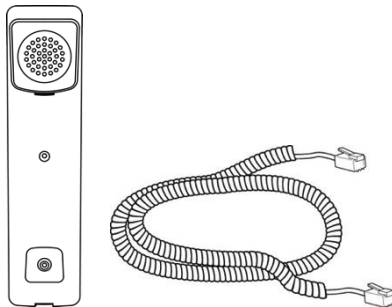

- Ethernet Cable

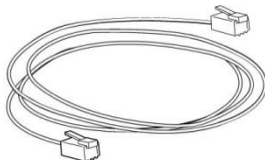

- Quick Installation Guide & Quick Reference Guide

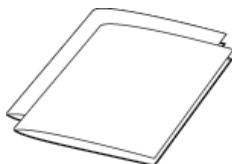

Check the list before installation. If you find anything missing, contact your system administrator.

Phone Installation

If your phone is already installed, proceed to [Phone Initialization](#) on page 14.

This section introduces how to install the phone:

- 1) Attach the stand or the optional wall mount bracket
- 2) Connect the handset and optional headset
- 3) Connect the network and power

- 1) Attach the stand or the optional wall mount bracket

Desk Mount Method

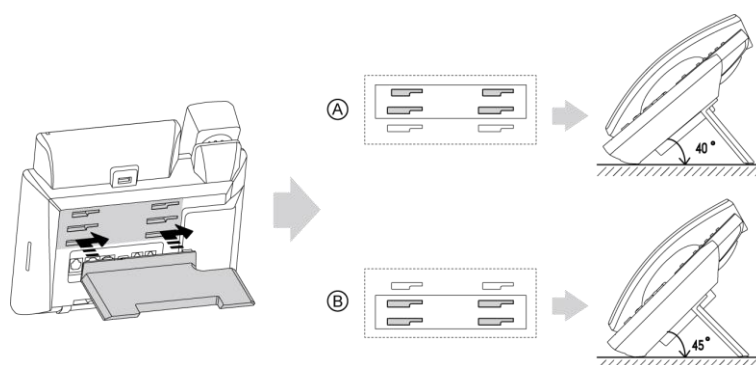

Wall Mount Method (Optional)

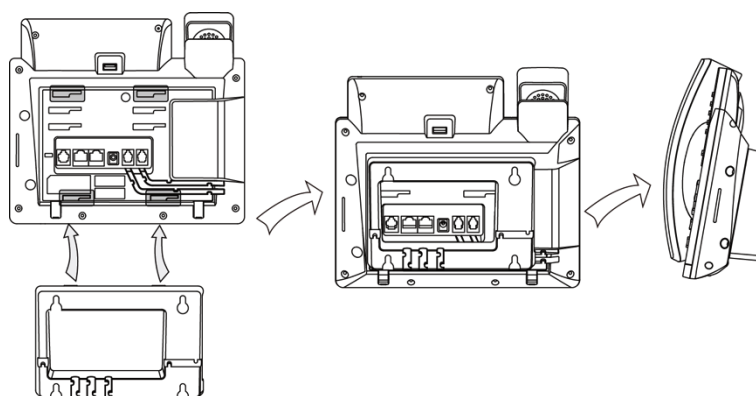

Note

The wall mount bracket should be purchased separately. For more information on how to attach the wall mount bracket, refer to *Commander Wall Mount Quick Installation Guide for T4X IP Phones*.

2) Connect the handset and optional headset

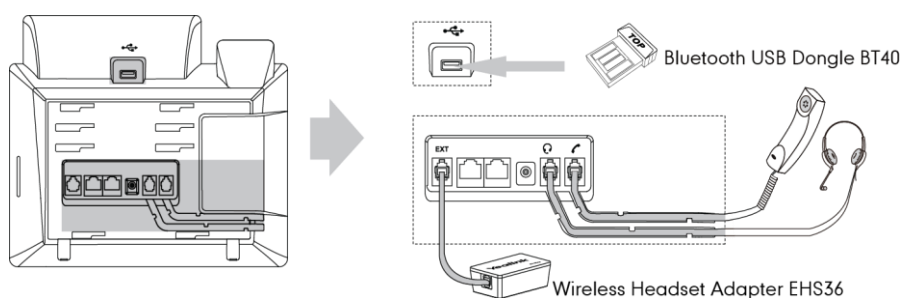

Note

The headset, wireless headset adapter EHS36 and Bluetooth USB dongle BT40 should be purchased separately.

The EXT port can also be used to connect an expansion module EXP40.

For more information on how to use EHS36, EXP40 and Bluetooth USB Dongle BT40, refer to *Commander EHS36 User Guide*, *Commander EXP40 User Guide* and *Commander Bluetooth USB Dongle BT40 User Guide*.

3) Connect the network and power

You have two options for power and network connections. Your system administrator will advise you which one to use.

- AC power (Optional)
- Power over Ethernet (PoE)

AC Power (Optional)

To connect the AC power:

1. Connect the DC plug on the power adapter to the DC5V port on the phone and connect the other

end of the power adapter into an electrical power outlet.

2. Connect the included or a standard Ethernet cable between the Internet port on the phone and the one on the wall or switch/hub device port.

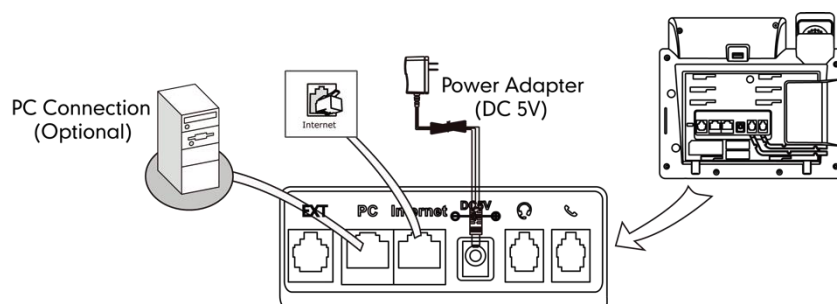

Power over Ethernet

With the included or a regular Ethernet cable, the Commander Office T46G IP phone can be powered from a Power over Ethernet compliant switch or hub.

To connect via PoE:

1. Connect the Ethernet cable between the Internet port on the phone and an available port on the PoE switch.

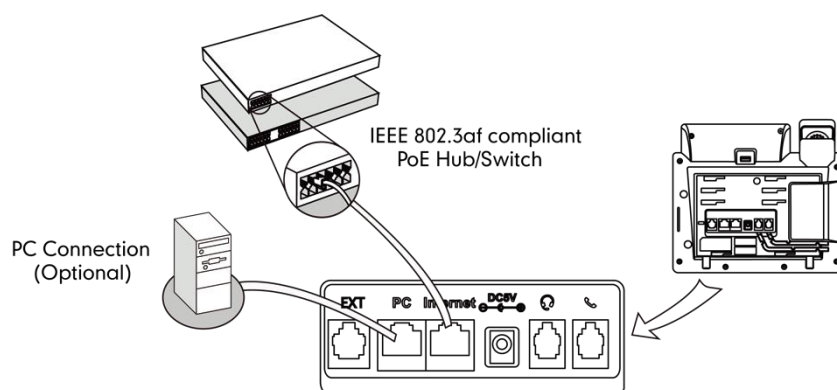

Note

If a Power over Ethernet (PoE) switch is provided, you don't need to connect the phone to the power adapter. Make sure the switch is PoE-compliant.

The phone can also share the network with another network device such as a PC (personal computer). It is an optional connection.

Important! Do not unplug or remove power to the phone while it is updating firmware and configurations.

Phone Initialization

After your phone is powered on, the system boots up and performs the following steps:

Automatic Phone Initialization

The phone finishes the initialization by loading the saved configuration. The LCD screen displays "Initializing...Please wait" during this process.

DHCP (Dynamic Host Configuration Protocol)

The phone attempts to contact a DHCP server in your network to obtain valid IPv4 network settings (e.g., IP address, subnet mask, default gateway address and DNS address) by default.

Note

If your network does not use DHCP, proceed to [Basic Network Settings](#) on page 15.



Phone Status

You can view phone status via phone user interface or web user interface.

Available information of phone status includes:

- Network status (e.g., IPv4 status, IPv6 status, IP address mode and MAC address).
- Phone status (e.g., device model, firmware version and product ID).
- Account status (e.g., register status of SIP accounts).

To view the phone status via phone user interface:

1. Press , or press Menu->Status.
2. Press  or  to scroll through the list and view the specific information.

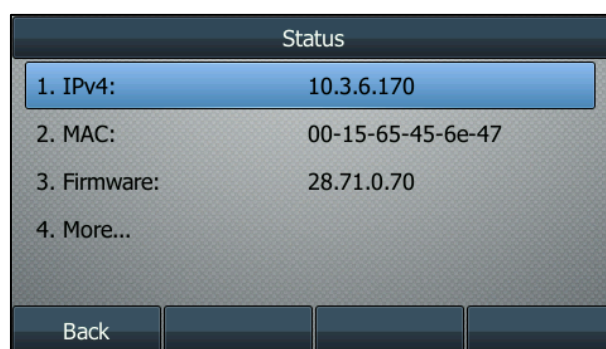

To view the phone status via web user interface:

1. Open the web browser on your computer.
2. Enter the IP address in the browser's address bar, and then press the Enter key.
3. Enter the user name (admin) and password (admin) in the login page.
4. Click Confirm to login.

The phone status is displayed on the first page of the web user interface.

Basic Network Settings

Your handset is designed to work on a local area network with IPv4 IP addresses assigned by DHCP.

If your phone cannot contact a DHCP server for any reason, you need to configure your network settings to allow this to occur. If you are unsure how to do this please contact your network administrator.

Idle Screen

If the phone has successfully started up, the idle LCD screen will be shown as below.

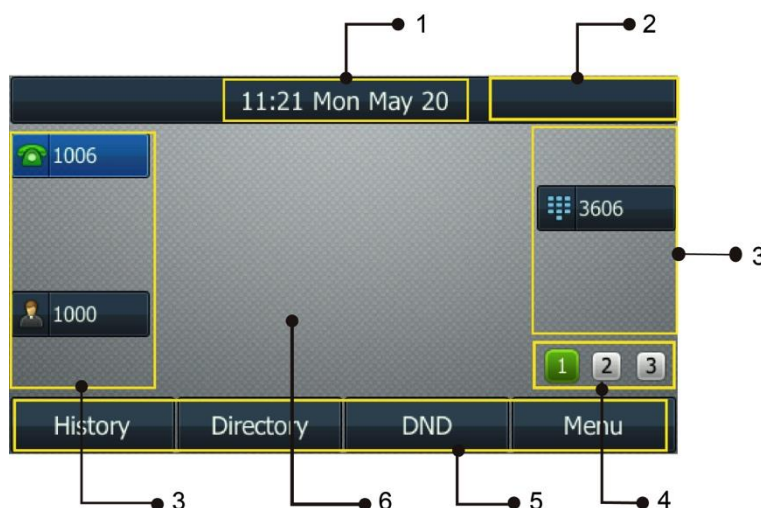

Idle Screen description:

No.	Description
1	This area shows the phone's time and date.
2	This area shows the phone feature status. For more information, refer to Icon Instructions on page 3.
3	This area shows the line key labels. You can customise the line key as other functions. For more information, refer to Line Keys on page 55.
4	This area shows three page icons.
5	This area shows the soft key labels. The default soft key labels are "History", "Directory", "DND" and "Menu".
6	This area shows the wallpaper. You can customise the wallpaper. For more information, refer to Wallpaper on page 16.

Customising Your Phone

You can customise your Commander Office T46G IP phone by personally configuring certain settings, for example, contrast, time & date and ring tones. You can add contacts to the phone's local directory manually or from call history. You can also personalise different ring tones for different callers.

This chapter provides basic operating instructions for customizing your phone. Topics include:

- [General Settings](#)
- [Audio Settings](#)
- [Contact Management](#)
- [Call History Management](#)
- [System](#)

If you require additional information or assistance with your new phone, contact your system administrator.

General Settings



Wallpaper

You can customise the wallpaper of the Commander Office T46G IP phone. You can change the wallpaper image via phone user interface or web user interface. You can also upload custom wallpaper images via web user interface. The file format of wallpaper image must be .jpg, .png or .bmp. Contact your system administrator for the detailed requirement of the file format.

To change the wallpaper via phone user interface:

1. Press Menu->Basic->Display->Wallpaper.



2. Press  or , or the Switch soft key to select the desired wallpaper image.
3. Press the Save soft key to accept the change or the Back soft key to cancel.

Wallpaper is configurable via web user interface at the path Settings->Preference.

To upload the customised wallpaper via web user interface:

1. Click on Settings->Preference.
2. In the Upload Wallpaper field, click Browse to select the wallpaper image from your local system.

3. Click Upload to upload the file.
4. Click Confirm to accept the change.

The customised wallpaper appears in the pull-down list of Wallpaper.

Backlight

You can configure backlight to adjust the brightness of the LCD screen. Backlight On Intensity is used to adjust the backlight intensity of the LCD screen. Backlight time specifies the delay time to turn off or dusky the backlight when the IP phone is inactive. Backlight Idle Intensity decides whether the IP phone turns off or dusky the backlight of the LCD screen after a period of inactivity.

You can configure the backlight status on the LCD screen as the following types:

- Always On: Backlight is on permanently.
- 1min, 2min, 5min, 10min, 30min: Backlight goes out or turns dusky when the phone has been inactive for approximately 1min, 2min, 5min, 10min or 30min.

To configure the backlight via phone user interface:

1. Press Menu->Basic->Display->General.

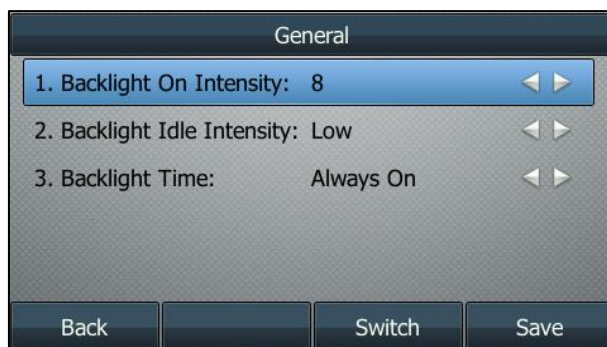

2. Press ◀ or ▶, or the Switch soft key to select the desired level from the Backlight On Intensity field.
3. Press ◀ or ▶, or the Switch soft key to select the desired value from the Backlight Idle Intensity field.
4. Press ◀ or ▶, or the Switch soft key to select the desired time from the Backlight Time field.
5. Press the Save soft key to accept the change or the Back soft key to cancel.

Backlight is configurable via web user interface at the path Settings->Preference.

Contrast

You can configure the contrast of the expansion module (EXP40) to a comfortable level. Ensure the expansion module has been connected to the phone.

To configure the contrast via phone user interface:

1. Press Menu->Advanced (password: admin) ->Phone Settings->Contrast.



2. Press ◀ or ▶, or the Switch soft key to increase or decrease the intensity of contrast. The default contrast level is 6.
3. Press the Save soft key to accept the change or the Back soft key to cancel.



Language

The default language of the phone user interface is English. The phone will detect and use the same language as which of your web browser for the web user interface. If the language of your web browser is not supported by the phone, the web user interface will use English by default. You can change the language for the phone user interface and the web user interface respectively.

Note

Not all of the supported languages are available for selection. The available languages depend on the language packs currently loaded to the IP phone. Please contact your system administrator for more information on the available languages of your new phone.

To change the language for the phone user interface:

1. Press Menu->Basic->Language.
2. Press  or  to select the desired language.



3. Press the Save soft key to accept the change.
Text displayed on the phone user interface will change to the selected language.

To change the language for the web user interface:

1. Click on Settings->Preference.

2. Select the desired language from the pull-down list of Language.

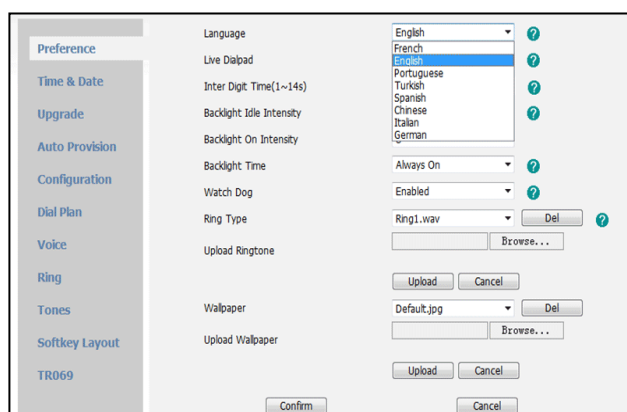

3. Click Confirm to accept the change.

Text displayed on the web user interface will change to the selected language.

Time & Date

The time and date are displayed on the LCD screen when the phone is idle. This is configured automatically by the Commander Phone service.

To configure the time and date manually via phone user interface:

1. Press Menu->Basic->Time & Date->General->Manual Settings.
2. Enter the specific date and time.

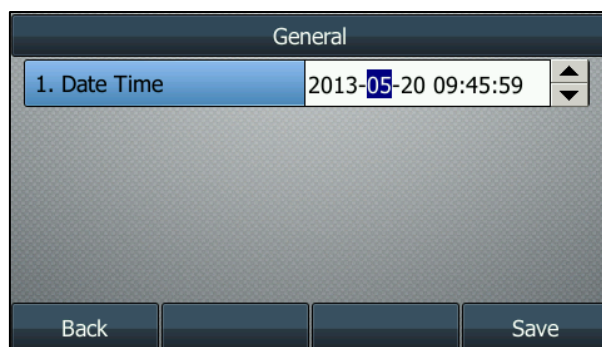



3. Press the Save soft key to accept the change.



The time and date displayed on the LCD screen will change accordingly.

To configure the date and time format via phone user interface:

1. Press Menu->Basic->Time & Date->Format.

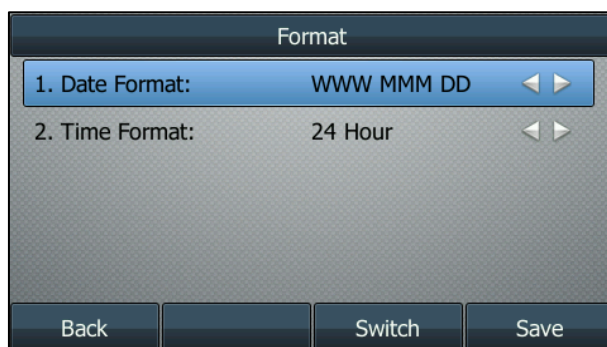
- Press  or , or the Switch soft key to select the desired date format from the Date Format field.



- Press  or , or the Switch soft key to select the desired time format (12 Hour or 24 Hour) from the Time Format field.
- Press the Save soft key to accept the change or the Back soft key to cancel.

There are 7 available date formats. For example, for the date format “WWW DD MMM”, “WWW” represents the abbreviation of the week, “DD” represents the two-digit day, and “MMM” represents the first three letters of the month.

The date formats you need to know:

Date Format	Example (2013-7-27)
WWW MMM DD	Sat Jul 27
DD-MMM-YY	27-Jul-13
YYYY-MM-DD	2013-07-27
DD/MM/YYYY	27/07/2013
MM/DD/YY	07/27/13
DD MMM YYYY	27 Jul 2013
WWW DD MMM	Sat 27 Jul

Time and date is configurable via web user interface at the path Settings->Time & Date.

Keypad Lock

You can lock the keypad of your phone temporarily when you are not using it. This feature helps to protect your phone from unauthorised use.

Keypad lock consists of the following:

Menu Key: The Menu soft key is locked. You cannot access the menu of the phone until unlocked.





Function Keys: The function keys are locked. You cannot use the MESSAGE, REDIAL, HOLD, MUTE, TRANSFER, OK, X, navigation keys, soft keys and line keys until

- unlocked.
- All Keys: All keys are locked except the Volume key. You are only allowed to dial emergency numbers, reject incoming calls by pressing the X key, answer incoming calls by lifting the handset, pressing the Speakerphone key, the HEADSET key or the OK key, mute an active call by pressing the X key, place an active call on hold by pressing the Hold soft key, resume the held call by pressing the Resume soft key, and end the call by hanging up the handset or pressing the Speakerphone key.

Note

The emergency number setting, if desired, must be made before lock activation. For more information, refer to [Emergency Number](#) on page 66.

To activate the keypad lock via phone user interface:

1. Press Menu->Advanced (password: admin) ->Phone Settings->Keypad Lock.
2. Press  or , or the Switch soft key to select Enabled from the Keypad Lock Enable field.
3. Press  or , or the Switch soft key to select the desired type from the Keypad Lock Type field.

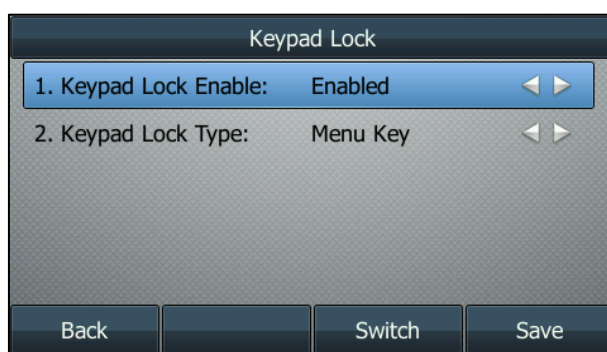

4. Press the Save soft key to accept the change.
Long press  to lock the keypad immediately when the phone is idle.

The LCD screen prompts “Keypad Lock!” and displays the icon  .

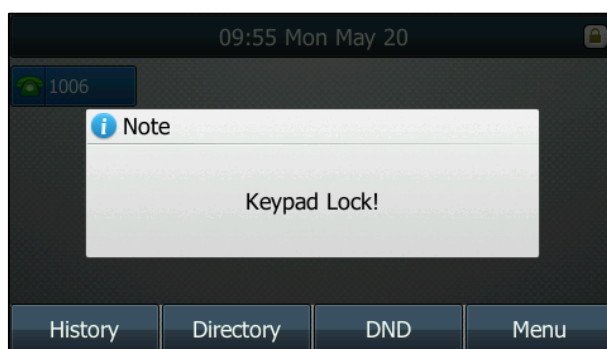

You can configure the interval (in seconds) to automatically lock the keypad instead of long pressing  .

To configure the interval of automatic keypad lock via web user interface:

1. Click on Features->Phone Lock.
2. Enter the desired time in the Phone Lock Time Out (0~3600s) field.

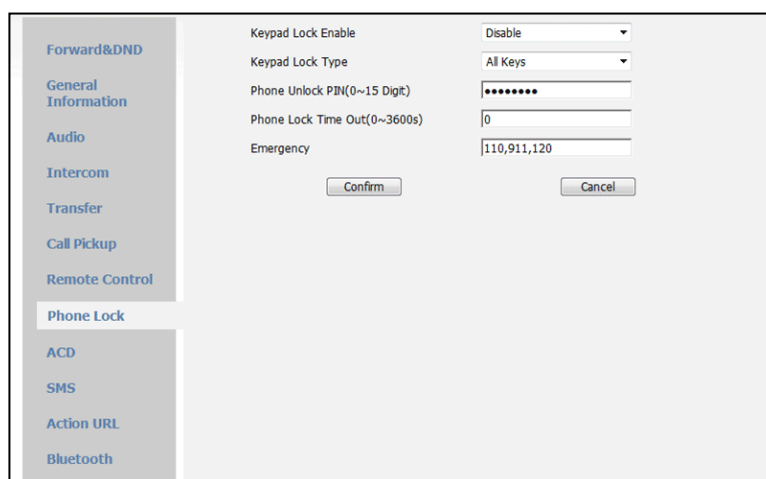

3. Click Confirm to accept the change.

Note

The default timeout is 0 second, that is, you can long press  to lock the keypad only. Interval of automatic keypad lock is configurable via web user interface only.

To unlock the keypad, you must know the keypad unlock PIN of the phone. The default keypad unlock PIN is “123”.

To change the keypad unlock PIN via phone user interface:

1. Press Menu->Basic->Phone Unlock PIN.
2. Enter the desired values in the Current PIN, New PIN and Confirm PIN fields respectively.

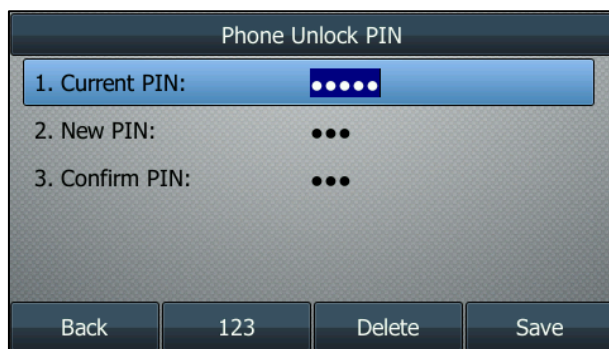

3. Press the Save soft key to accept the setting or the Back soft key to cancel.

Note

The unlock PIN length must be within 15 characters.

To unlock the keypad via phone user interface:

1. Press any locked key, the LCD screen prompts "Unlock PIN".

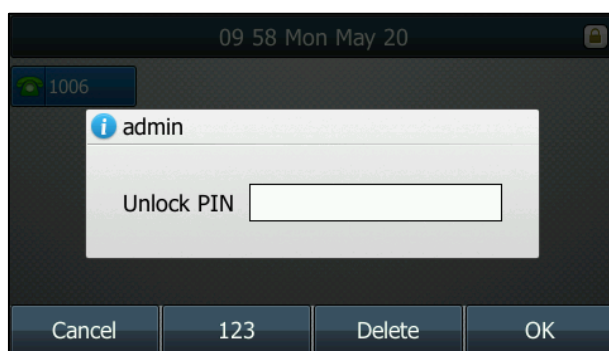

2. Enter the PIN in the Unlock PIN field.
3. Press the OK soft key to unlock the keypad.

The  icon disappears from the LCD screen.



You can long press  or wait for a period of time (if configured) to lock the keypad again.

Note

You can also unlock the keypad by administrator password.

To deactivate the keypad lock via phone user interface:

1. Press Menu->Advanced (password: admin) ->Phone Settings->Keypad Lock.

2. Press  or , or the Switch soft key to select Disabled from the Keypad Lock Enable field.

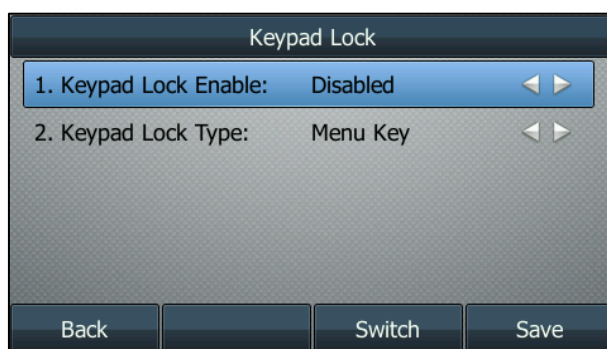

3. Press the Save soft key to accept the change.

Keypad lock is configurable via web user interface at the path Features->Phone Lock.

Audio Settings

Volume

You can press the volume key to adjust the ringer volume when the phone is idle. You can also press the volume key to adjust the receiver volume of currently engaged audio devices (handset, speakerphone or headset) when the phone is in use.

To adjust the volume when the phone is idle:

1. Press  to adjust the ringer volume.



Note

If ringer volume is adjusted to minimum, the  icon will appear on the LCD screen.

To adjust the volume when the phone is during a call:



1. Press  to adjust the volume of currently engaged audio device (handset, speakerphone or headset).



Ring Tones

Ring tones are used to indicate incoming calls. You can select different ring tones to distinguish different accounts registered on your phone, or to distinguish your phone from your neighbor's.

To select a ring tone for the phone via phone user interface:

1. Press Menu->Basic->Sound->Ring Tones.
2. Press  or  to select the desired ring tone.



3. Press the Save soft key to accept the change or the Back soft key to cancel.

To select a ring tone for the account via web user interface:

1. Click on Account.
2. Select the desired account from the pull-down list of Account.
3. Click on Basic.
4. Select the desired ring tone from the pull-down list of Ring Type.

If Common is selected, this account will use the ring tone selected for the phone. Refer to the above instruction.

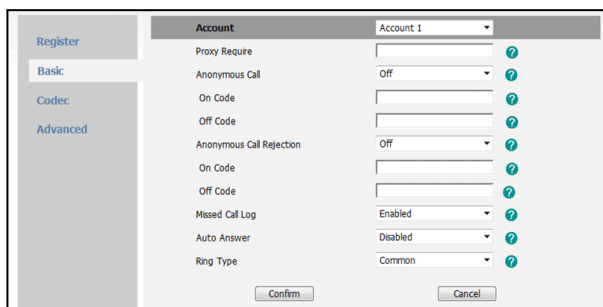

5. Click Confirm to accept the change.

Note

A ring tone for the account is configurable via web user interface only. The ring tone for an incoming call on the phone may be different. For example, when the phone receives an incoming call from a contact stored in the local directory, it will play the ring tone assigned to the contact in the local directory (refer to [Adding Contacts](#)). If no ring tone is assigned to the contact, the phone will play the ring tone assigned to the associated group (refer to [Groups](#)). Otherwise, the phone will play the ring tone assigned to the account. If no ring tone is assigned to the contact and account, the phone will play the ring tone assigned to the phone.

To upload a custom ring tone for your phone via web user interface:

1. Click on Settings->Preference.
2. In the Local Ringtone field, click Browse to locate a ring tone (the file format must be .wav) file from your local system.

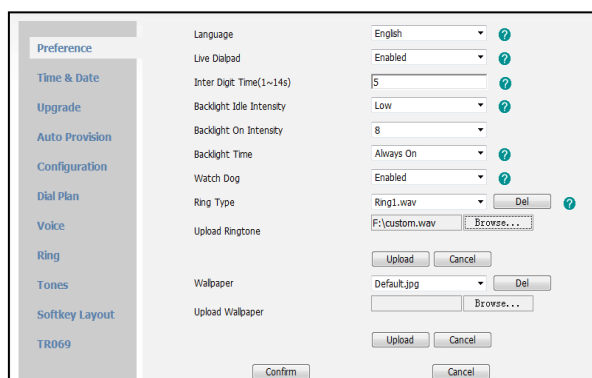

3. Click Upload to upload the file.

Note

All custom ring tone files must be within 100KB. Uploading custom ring tones for your phone is configurable via web user interface only.

Contact Management





This section provides the operating instructions for managing contacts. Topics include:

- [Directory](#)
- [Local Directory](#)
- [Blacklist](#)
- [Remote Phone Book](#)

Directory

Directory provides easy access to frequently used lists. The lists may contain Local Directory, History, Remote Phone Book and LDAP.

To configure the directory via web user interface:

1. Click on Directory->Setting.
2. In the Directory block, select the desired list from the Disabled column and then click  .
The selected list appears in the Enabled column.
3. Repeat the step 2 to add more lists to the Enabled column.
4. To remove a list from the Enabled column, select the desired list and then click  .
5. To adjust the display order of enabled lists, select the desired list and then click  or  .

The LCD screen displays the list(s) in the adjusted order.

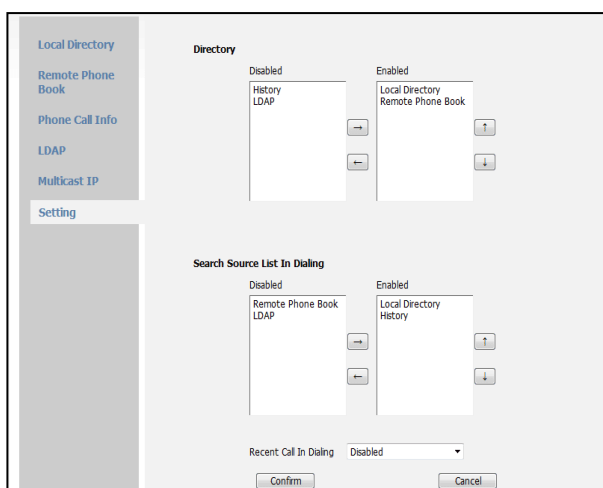

6. Click Confirm to accept the change.

Note Directory is configurable via web user interface only.

To check directory via phone user interface:

1. Press the Directory soft key when the phone is idle.

The LCD screen displays the enabled list(s) in the directory.



If there is only one list in the directory, press the Directory soft key to enter this list directly.

Note If the remote phone book and LDAP are not configured in advance, you cannot see remote phone book and LDAP lists on the phone user interface. For more information on remote phone book, refer to [Remote Phone Book](#) on page 45. For more information on the LDAP, contact your system administrator.

Local Directory

The built-in phone directory can store the names and phone numbers of your contacts. You can store up to 1000 contacts and 50 groups in your phone's local directory. There are four default groups in the

local directory: All Contacts, Company, Family and Friend. You can add new groups and contacts; edit, delete or search for a contact; or simply dial a contact number from the local directory.

Groups

To add a group to the local directory:

1. Press the Directory soft key.

The IP phone enters the local directory directly as there is only Local Directory in the directory by default.

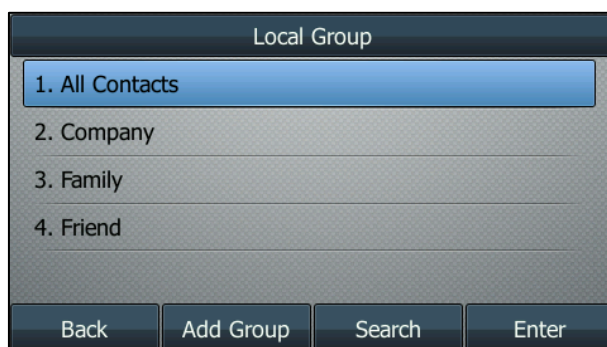

If Local Directory is removed from the directory, press Menu->Directory->Local Group to enter the local directory.

2. Press the Add Group soft key.
3. Enter the desired group name in the Group Name field.
4. Press or to select the desired group ring tone from the Ring Tones field.

If Auto is selected, this group will use the ring tone assigned to the account. For more information on the ring tone for the account, refer to [Ring Tones](#) on page 27.



5. Press the Save soft key to accept the change or the Back soft key to cancel.

You can also edit or delete the Company, Family and Friend contact groups.

To edit a group in the local directory:

1. Press the Directory soft key.

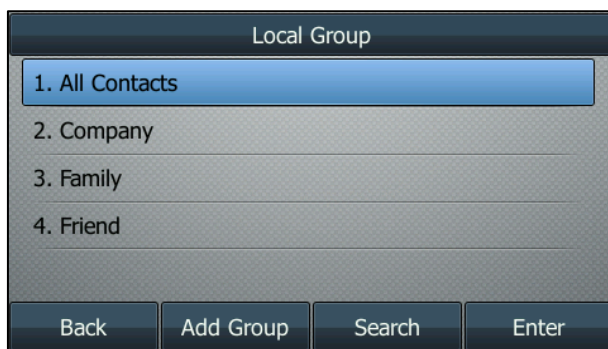

The IP phone enters the local directory directly as there is only Local Directory in the directory by default.

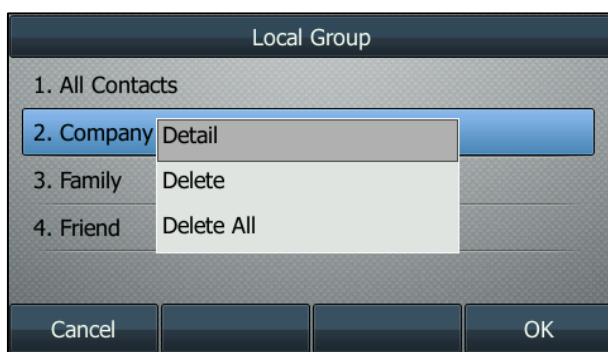

If Local Directory is removed from the directory, press Menu->Directory->Local Group to enter the local directory.

2. Select the desired contact group.
3. Press the Option soft key and then select Detail from the prompt list.



4. Press  or  to highlight the group information and then edit.
5. Press the Save soft key to accept the change or the Back soft key to cancel.

To delete a group from the local directory:

1. Press the Directory soft key.

The IP phone enters the local directory directly as there is only Local Directory in the directory by default.

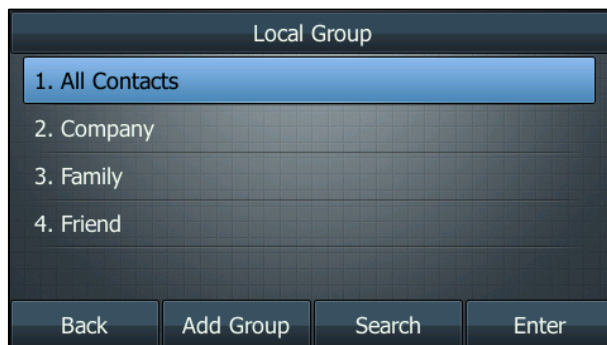

If Local Directory is removed from the directory, press Menu->Directory->Local Group to enter the local directory.

2. Select the desired contact group.
3. Press the Option soft key and then select Delete from the prompt list.

The LCD screen prompts the following warning:

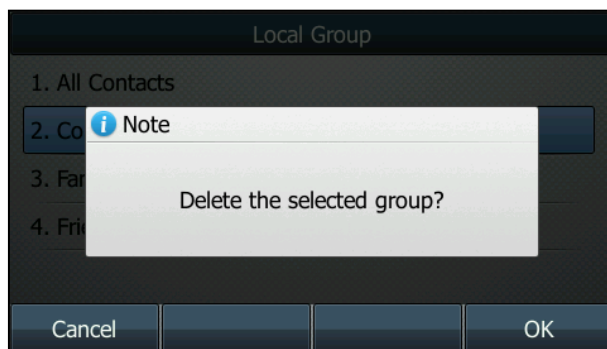

4. Press the OK soft key to confirm the deletion or the Cancel soft key to cancel.

Adding Contacts

You can add contacts to the local directory in the following ways:

- Manually
- From call history
- From remote phone book

Adding Contacts Manually

To add a contact to the local directory manually:

1. Press the Directory soft key.

The IP phone enters the local directory directly as there is only Local Directory in the directory by default.

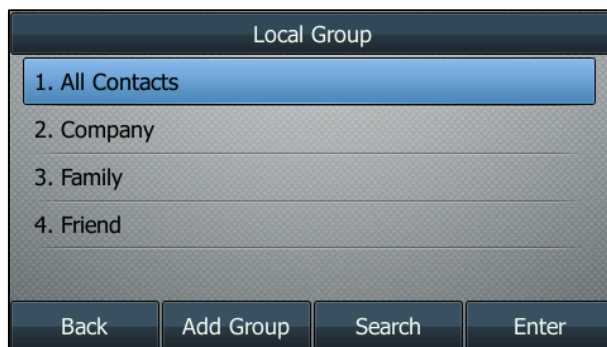

If Local Directory is removed from the directory, press Menu->Directory->Local Group to enter the local directory.

2. Select the desired contact group and press the Enter soft key.
3. Press the Add soft key.
4. Enter the name and the office, mobile or other numbers in the corresponding fields.

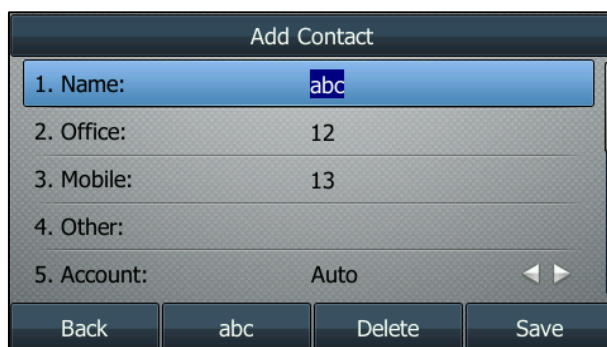



5. Press ◀ or ▶, or the Switch soft key to select the desired account from the Account field.
If Auto is selected, the phone will use the first available account when placing calls to the contact from the local directory.
6. Press ◀ or ▶, or the Switch soft key to select the desired ring tone from the Ring field.
If Auto is selected, this contact will use the ring tone assigned to the group.
7. Press ◀ or ▶, or the Switch soft key to select the desired photo from the Photo field.
8. Press the Save soft key to accept the change or the Back soft key to cancel.

Note

If the contact has existed in the directory, the LCD screen will prompt "Contact name already existed!".

Adding Contacts from Call History

To add a contact to the local directory from the call history:

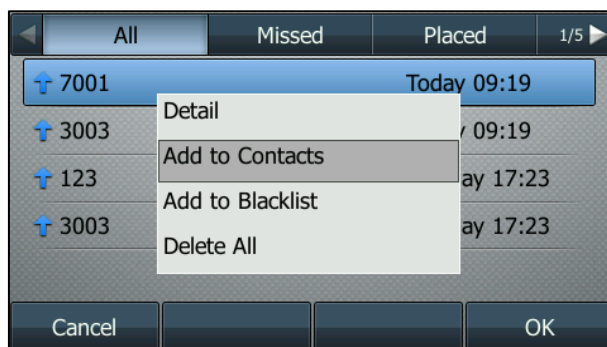

1. Press the History soft key.
2. Press  or  to highlight the desired entry.
3. Press the Option soft key, and then select Add to Contacts from the prompt list.



4. Enter the contact name.
5. Press the Save soft key to accept the change.
The entry is successfully saved to the local directory.

Adding Contacts from remote phone book

To add a contact to the local directory from remote phone book:

1. Press Directory->Remote Phone Book.
If Remote Phone Book is removed from the directory, press Menu->Directory->Remote Phone Book to enter remote phone book.
2. Select the desired remote group and press the Enter soft key.
3. Press  or  to highlight the desired entry.
4. Press the Option soft key, and then select Add to Contacts from the prompt list.
5. Press the Save soft key to save the contact to the local directory.

If the contact has already existed in the local directory, the LCD screen will prompt "Overwrite the original contact?". Press the OK soft key to overwrite the original contact in the local directory or the Cancel soft key to cancel.

For more information on remote phone book operating, refer to [Remote Phone Book](#) on page 45.

Editing Contacts



To edit a contact in the local directory:

1. Press the Directory soft key.

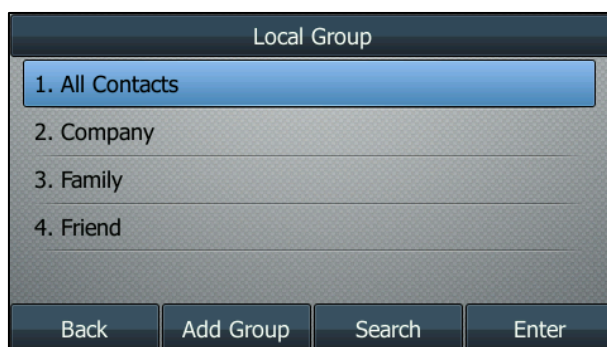

The IP phone enters the local directory directly as there is only Local Directory in the directory by default.

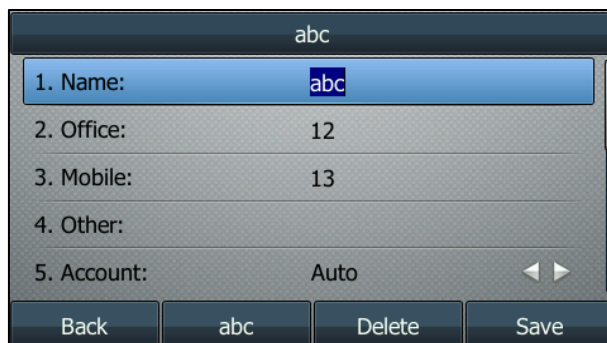

If Local Directory is removed from the directory, press Menu->Directory->Local Group to enter the local directory.

2. Select the desired contact group and press the Enter soft key.
3. Press  or  to highlight the desired contact.
4. Press the Option soft key, and then select Detail from the prompt list.



5. Press  or  to highlight the contact information and then edit.
6. Press the Save soft key to accept the change or the Back soft key to cancel.

Deleting Contacts



To delete a contact from the local directory:

1. Press the Directory soft key.

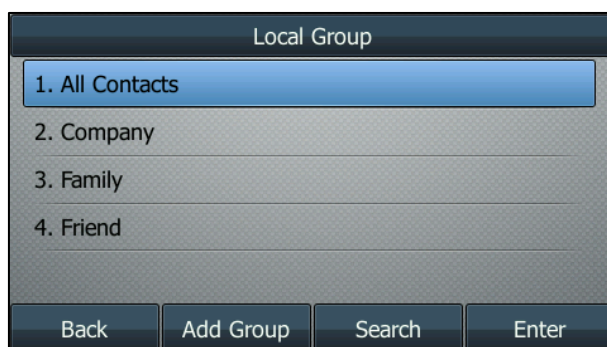
The IP phone enters the local directory directly as there is only Local Directory in the directory by default.



If Local Directory is removed from the directory, press Menu->Directory->Local Group to enter the local directory.

2. Select the desired contact group and press the Enter soft key.
3. Press  or  to highlight the desired contact.
4. Press the Option soft key, and then select Delete from the prompt list.

The LCD screen prompts the following warning:

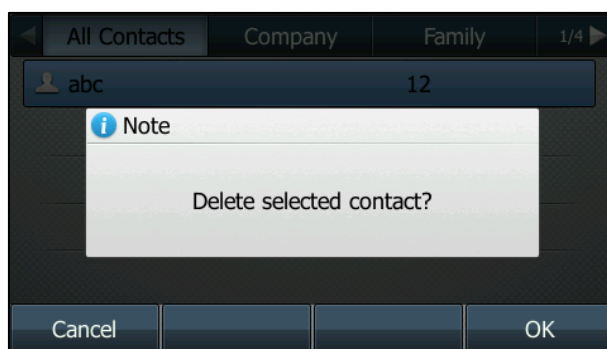

5. Press the OK soft key to confirm the deletion or the Cancel soft key to cancel.

You can also delete all contacts by pressing the Option soft key, and then select Delete All.

Uploading Contact Photos

To upload a new custom photo for the contact via web user interface:

1. Click on Directory->Local Directory.
2. Click Browse, and then select a photo from your local computer.
3. Click Upload Photo to upload the photo.

You can also click Delete Photo to delete the photo.

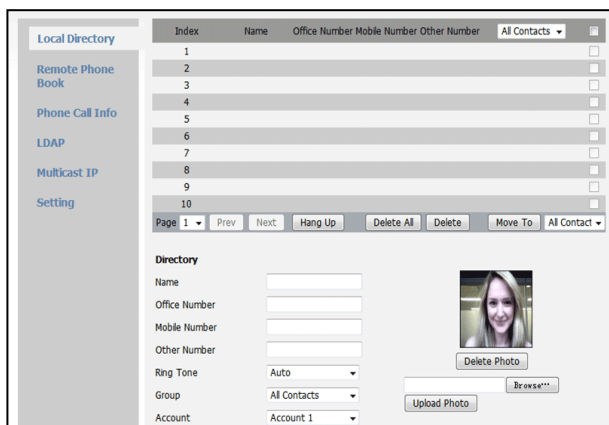

Note

The phone only supports the .png, .jpg and .bmp format files.
You can only delete the custom photo.

To change the custom photo for the contact via web user interface:

1. Click on Directory->Local Directory.
2. Click to select the desired entry which you want to edit.
3. Select the desired photo from the pull-down list of Photo.
4. Click Edit to accept the change.

When you place a call to the contact or receive a call from the contact, the LCD screen will show the contact photo.

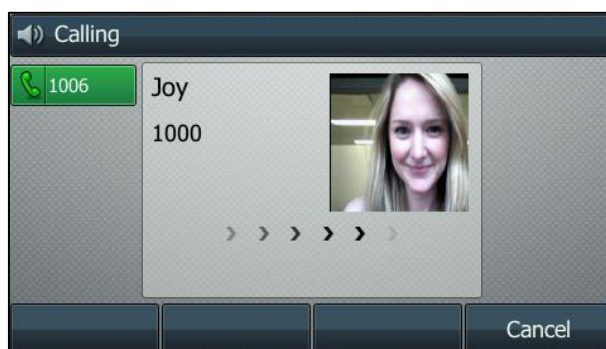

Placing Calls to Contacts



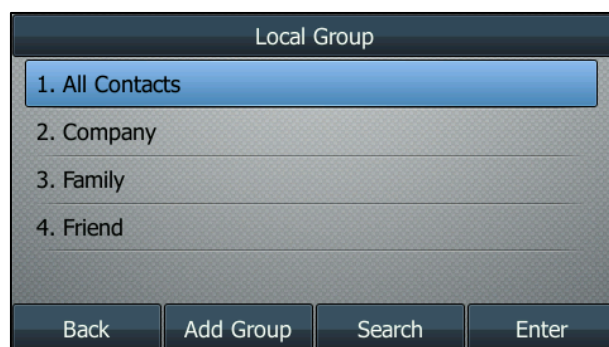

To place a call to a contact from the local directory:

1. Press the Directory soft key.

The IP phone enters the local directory directly as there is only Local Directory in the directory by default.



If Local Directory is removed from the directory, press Menu->Directory->Local Group to enter the local directory.

2. Select the desired contact group and press the Enter soft key.
3. Press  or  to highlight the desired contact.
4. Do one of the following:
 - If only one number of the contact is stored in the local directory, press the Send soft key to dial out the number.
 - If multiple numbers of the contact are stored in the local directory, press the Send soft key to display a list of numbers.
 - Press  or  to highlight the desired number.
 - Press the Send soft key to dial out the number.

Searching for Contacts

To search for a contact in the local directory:

1. Press the Directory soft key.

The IP phone enters the local directory directly as there is only Local Directory in the directory by default.

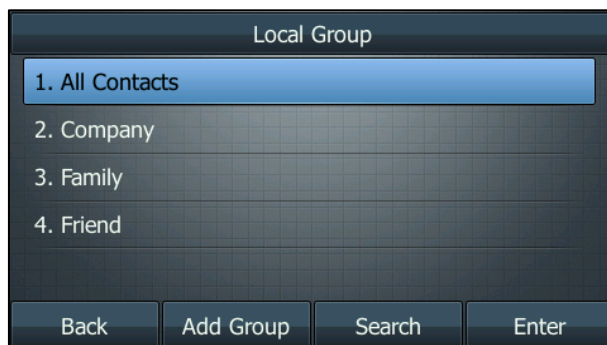

If Local Directory is removed from the directory, press Menu->Directory->Local Group to enter the local directory.

2. Press the Search soft key.
3. Enter a few continuous characters of the contact name or the contact number using the keypad.

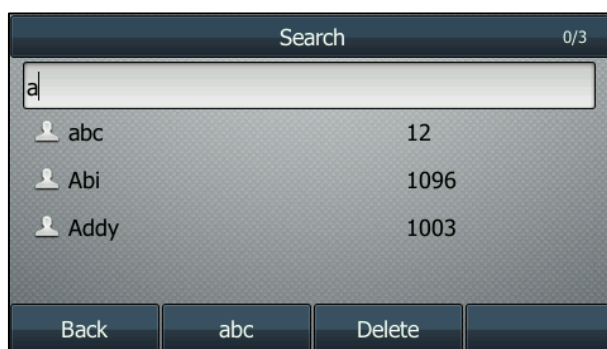

The contacts whose name or phone number matches the characters entered will appear on the LCD screen. You can dial from the result list.



Search Source List in Dialing

You can search for a contact from the desired lists when the phone is in the dialing screen. The lists can be Local Directory, History, Remote Phone Book and LDAP.

To configure search source list in dialing via web user interface:

1. Click on Directory->Setting.
2. In the Search Source List In Dialing block, select the desired list from the Disabled column and click .

The selected list appears in the Enabled column.

3. Repeat step 2 to add more lists to the Enabled column.
4. To remove a list from the Enabled column, select the desired list and then click .
5. To adjust the display order of the enabled list, select the desired list, and click  or .

The LCD screen displays the search results in the adjusted order.

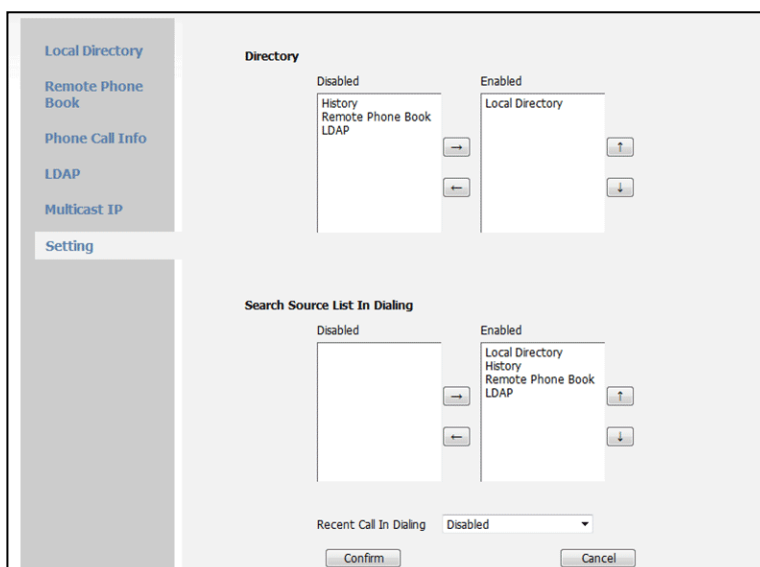



6. Click Confirm to accept the change.

Note

Search source list in dialing is configurable via web user interface only.

To search for an entry in the enabled search source lists:

1. Pick up the handset, press the speakerphone key or press the line key.
2. Enter a few continuous characters of the entry's name or the entry's phone number using the keypad.

The entries in the enabled search source lists whose name or phone number matches the characters entered will appear on the LCD screen. You can press  or  to scroll to the desired entry and then place a call to the entry.

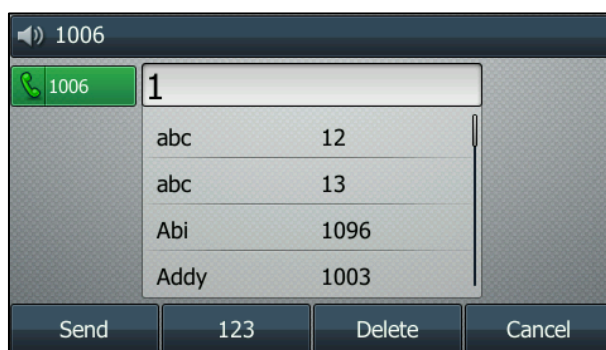

Importing/Exporting Contact Lists

You can manage your phone's local directory via phone user interface or web user interface. But you can only import or export the contact list via web user interface.

To import an XML file of contact list via web user interface:

1. Click on Directory->Local Directory.
2. Click Browse to locate a contact list file (file format must be .xml) from your local system.

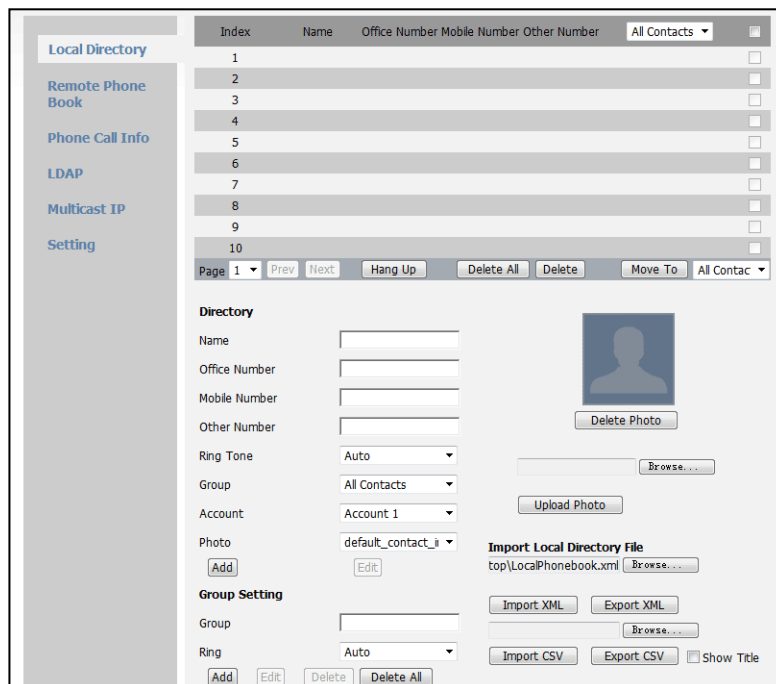

3. Click Import XML to import the contact list.
The web user interface prompts "The original contact will be covered, Continue?".
4. Click OK to complete importing the contact list.

To import a CSV file of contact list via web user interface:

1. Click on Directory->Local Directory.
2. Click Browse to locate a contact list file (file format must be .csv) from your local system.
3. (Optional.) Check the Show Title checkbox.
It will prevent importing the title of the contact information which is located in the first line of the CSV file.
4. Click Import CSV to import the contact list.
5. (Optional.) Mark the On radio box in the Delete Old Contacts field.
It will delete all existing contacts while importing the contact list.
6. (Optional.) Select the contact information you want to import into the local directory from the pull down list of Index.

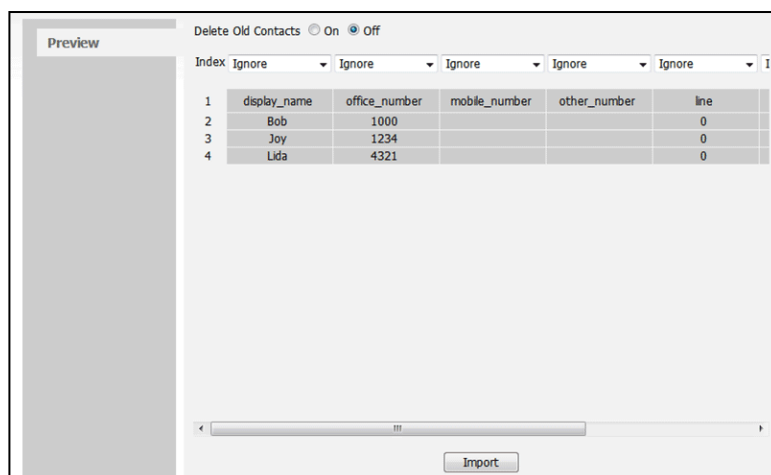

7. Click Import to complete importing the contact list.

To export a contact list via web user interface:

1. Click on Directory->Local Directory.
2. Click Export XML (or Export CSV).
3. Click Save to save the contact list to your local system.

Note

Importing/exporting contact lists is available via web user interface only.

Blacklist

The built-in phone directory can store the names and phone numbers for a blacklist. You can store up to 30 contacts; add, edit, delete or search for a contact in the blacklist directory; even call a contact from the blacklist directory, but incoming calls from the blacklist directory contacts will be rejected automatically.

To add a contact to the blacklist directory manually:

1. Press Menu->Directory->Blacklist.
2. Press the Add soft key.

3. Enter the name and the office, mobile or other numbers in the corresponding fields.

4. Press or , or the Switch soft key to select the desired account from the Account field. If Auto is selected, the phone will use the first available account when placing calls to the contact from the blacklist directory.
5. Press the Save soft key to accept the change or the Back soft key to cancel.

To add a contact to the blacklist directory from the local directory:

1. Press Directory soft key.

The IP phone enters the local directory directly as there is only Local Directory in the directory by default.

If Local Directory is removed from the directory, press Menu->Directory->Local Group to enter the local directory.

2. Select the desired contact group and press the Enter soft key.
3. Press or to highlight the desired contact.
4. Press the Option soft key and then select Add to Blacklist from the prompt list.

The LCD screen prompts the following warning:

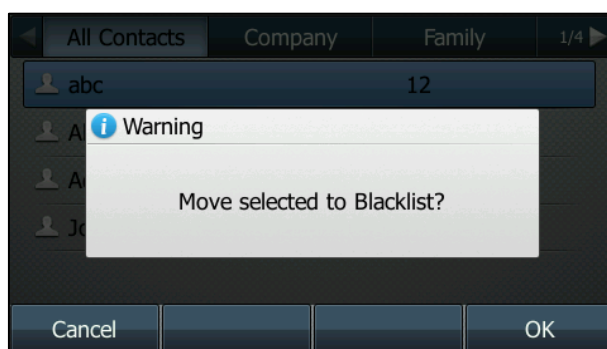

5. Press the OK soft key to confirm the setting.

For operating instructions on editing, deleting, placing calls to and/or searching for contacts in the blacklist directory, refer to the operating instructions of [Local Directory](#) on page 30.

Remote Phone Book

You can add local contacts, search for a contact, or simply dial a contact number from the corporate directory.

Your phone is configured to display your corporate directory

To access your corporate directory via phone user interface:

1. Press Directory->Remote Phone Book.
2. If this is the first time you have accessed the Remote Phone Book you may be prompted to enter a web access password. This password is your Command Central user password. If you change your Command Central user password you may be prompted to re-enter the password into the phone.
3. Select the desired remote group, and then press the Enter soft key.

The phone connects to load the corporate directory, and then the corporate contact list appears on the LCD screen.

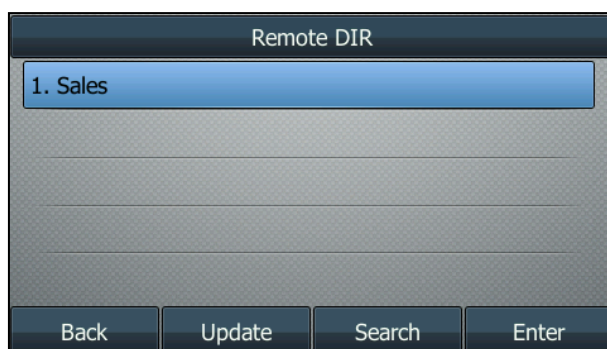

4. Press the Back soft key to back to the previous interface.

To search for a contact in the corporate directory:

1. Press Menu->Directory->Remote Phone Book.

If Remote Phone Book is added to the directory, press Directory->Remote Phone Book to enter remote phone book.

2. Select the desired remote group, and then press the Enter soft key to load the corporate directory.
3. Press the Search soft key.
4. Enter a few continuous characters of the contact name or continuous numbers of the contact number using the keypad.

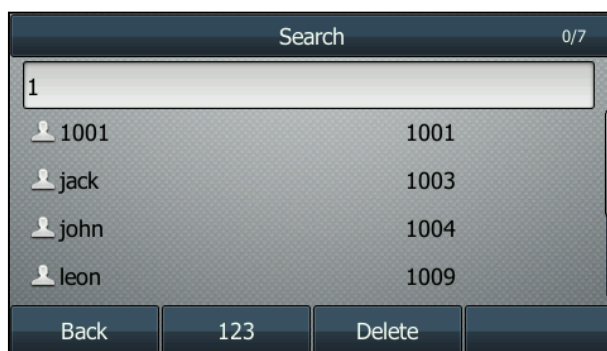

The contacts whose name or phone number matches the characters entered will appear on the LCD screen. You can place a call from the result list.

To place a call from the corporate directory:

1. Press Menu->Directory->Remote Phone Book.
If Remote Phone Book is added to the directory, press Directory->Remote Phone Book to enter remote phone book.
2. Select the desired remote group, and then press the Enter soft key to load the corporate directory.
3. Select the desired contact in the corporate directory.
4. Press the Send soft key.



Call History Management

The Commander Office T46G IP phone maintains call history lists of Missed calls, Placed calls, Received calls and Forwarded calls. Call history lists support 400 entries in all. You can view the call history, place a call, add a contact or delete an entry from the call history list. You should enable history record in advance.

By default your phone is configured to use the network call history. This will ensure that any calls made from other devices associated with your service will also appear in your phones history.

If this is the first time you have accessed the Network Call History you may be prompted to enter a web access password. This password is your Command Central user password. If you change your Command Central user password you may be prompted to re-enter the password into the phone



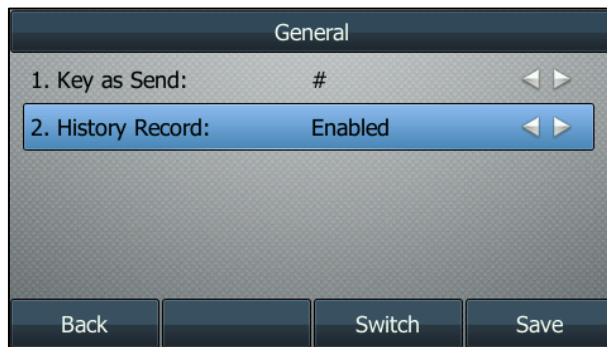

To enable history record via phone user interface:

1. Press Menu->Call Features->Others->General.
2. Press  or , or the Switch soft key to select Enabled from the History Record field.







3. Press the Save soft key to accept the change or the Back soft key to cancel.

To view the call history:





1. Press the History soft key.
The LCD screen displays all call records.
2. Press  or  to switch between All, Missed, Placed, Received and Forwarded call lists.
3. Press  or  to select the desired entry.
4. Press the Option soft key, and then select Detail from the prompt list.

The detailed information of the entry appears on the LCD screen.

To place a call from the call history list:





1. Press the History soft key.
2. Press  or  to switch between All, Missed, Placed, Received and Forwarded call lists.
3. Press  or  to select the desired entry.
4. Press the Send soft key.

To add a contact to the local directory (or blacklist directory) from the call history list:



1. Press the History soft key.
2. Press  or  to switch between All, Missed, Placed, Received and Forwarded call lists.
3. Press  or  to select the desired entry.
4. Press the Option soft key, and then select Add to Contacts (or Add to Blacklist) from the prompt list.
5. Enter the desired values in the corresponding fields.
6. Press the Save soft key.

For more information, refer to [Contact Management](#) on page 29.

To delete an entry from the call history list:

1. Press the History soft key.
2. Press  or  to switch between All, Missed, Placed, Received and Forwarded call lists.
3. Press  or  to select the desired entry.
4. Press the Delete soft key.

To delete all entries from the call history list:

1. Press the History soft key.
2. Press  or  to switch between All, Missed, Placed, Received and Forwarded call lists.
3. Press the Option soft key, and then select Delete All from the prompt list.
4. Press the OK soft key.

The LCD screen prompts "Delete all records?".

5. Press the OK soft key to confirm the deletion or the Cancel soft key to cancel.

System Customisations

Headset Use

If you want to use a wired headset, physically connect your headset and activate the headset mode for use. For more information on physically connecting a headset, refer to [Phone Installation](#) on page 11.

If you want to use a wireless headset, insert the Bluetooth USB dongle into the USB port on the back of

the phone. For more information on using a Bluetooth headset, refer to [Bluetooth Headset](#) on page 50.

This section provides the introduction of the wired headset.

Note

If both a Bluetooth headset and a wired headset are connected, only the Bluetooth headset can be used.

Headset Mode Activation/Deactivation

To activate the headset mode:

1. Press  on the phone.

The HEADSET key LED illuminates solid green when the headset mode is activated. Press the line key or the Answer soft key to answer an incoming call. The call will be connected to your headset automatically.

Enter the desired number and press the Send soft key, then the phone will place a call using the headset automatically. For more information on using the headset to place a call, refer to [Placing Calls](#) on page 69.

To deactivate the headset mode:

1. Press  again on the phone.

The HEADSET key LED goes out when the headset mode is deactivated.

Headset Prior

You can use headset in priority when enabling headset prior. This feature is especially useful for permanent or full-time headset users.

To enable headset prior via web user interface:

1. Click on Features->General Information.
2. Select Enabled from the pull-down list of Headset Prior.

3. Click Confirm to accept the change.

To use headset prior, you should activate the headset mode in advance:

1. Physically connect the headset.
2. Press  to activate the headset mode.

Note

If headset prior is enabled, the headset mode will not be deactivated until you press the **HEADSET** key again.

Headset prior is configurable via web user interface only.

Bluetooth Headset



The Commander Office T46G IP phone supports Bluetooth. Bluetooth enables low-bandwidth wireless connections within a range of 10 meters (32 feet). The best performance is in the 1- to 2-meter (3- to 6-foot) range.

You can activate/deactivate the Bluetooth mode, and then pair and connect the Bluetooth headset with your phone. You can also disconnect and delete your Bluetooth headset from the phone.

Note

Ensure that the Bluetooth USB dongle is properly connected into the USB port on the back of the phone. For more information, refer to [Phone Installation](#) on page 11.

To activate the Bluetooth mode via phone user interface:



1. Press Menu->Basic->Bluetooth.
2. Press  or  or the Switch soft key to select On from the Bluetooth field.



3. Press the Save soft key to accept the change.

The LCD screen displays the Bluetooth icon .

To deactivate the Bluetooth mode via phone user interface:

1. Press Menu->Basic->Bluetooth.
2. Press  or , or the Switch soft key to select Off from the Bluetooth field.



3. Press the Save soft key to accept the change.

The Bluetooth icon  disappears from the phone.

Bluetooth mode is configurable via web user interface at the path Features->Bluetooth.

Before you pair a Bluetooth headset, check the indicator on the Bluetooth headset to make sure the Bluetooth headset is discoverable. For more information, refer to the documentation from the Bluetooth headset manufacturer.

To pair and connect your Bluetooth headset to your phone:

1. Press Menu->Basic->Bluetooth.
2. Press the Scan soft key to search the Bluetooth devices.

The LCD screen prompts the following message:

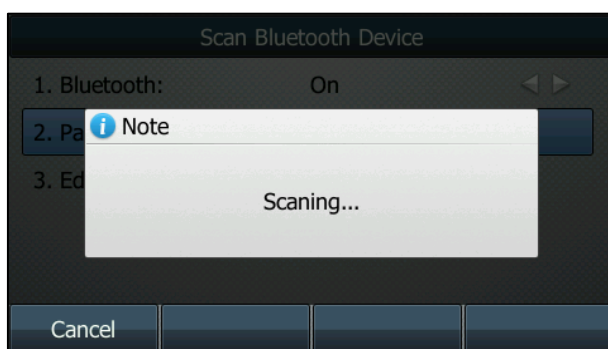

The phone proceeds to scan the local Bluetooth devices. When the phone completes scan, it will display the found Bluetooth devices on the LCD screen.



3. Select the desired Bluetooth headset and press Connect soft key.
4. Enter the PIN in the Password field.

The default PIN is "0000" or "1234".

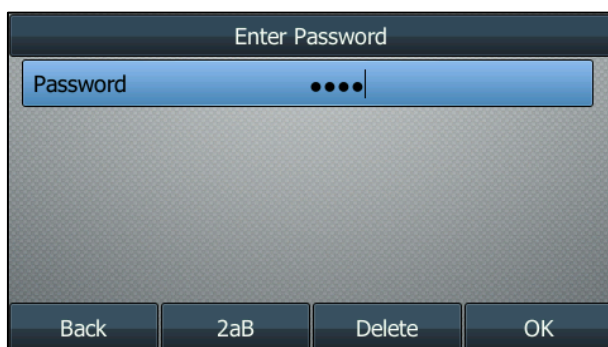

5. Press the OK soft key.

After a while, the Bluetooth headset is automatically connected to your phone.

The Bluetooth icon  appears on the LCD screen.



With the Bluetooth headset paired and connected, you can use the Bluetooth headset to place and answer calls. For more information, refer to the documentation from the Bluetooth headset manufacturer.

To view the Bluetooth headset information:

1. Press Menu->Basic->Bluetooth->Paired Bluetooth Device.

The LCD screen displays a list of paired and connected Bluetooth headsets.



2. Select the desired Bluetooth headset.
3. Press the Option soft key, and then select Detail from the prompt list to view the Bluetooth headset information:
 - Device Name: the name of the Bluetooth headset.
 - MAC Address: the MAC address of the Bluetooth headset.

- **Auto Connection:** Enables or disables the Bluetooth headset to connect with the phone automatically.

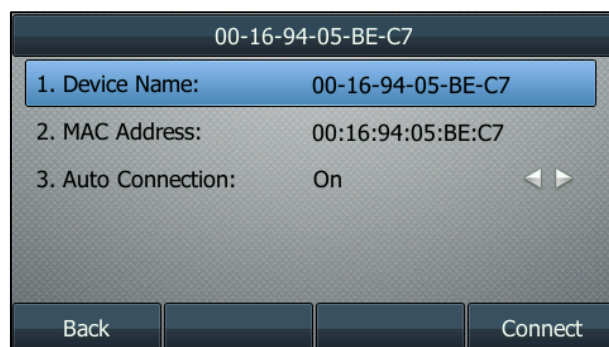

To change the priority of paired Bluetooth devices:

1. Press Menu->Basic->Bluetooth->Paired Bluetooth Device.
2. Select the desired Bluetooth headset.
3. Press the Option soft key, and then select Move Up or Move Down from the prompt list.

The top one has the highest priority. When there is no Bluetooth headset connected, the phone will automatically connect to the Bluetooth headset with the highest priority.

You can disconnect the Bluetooth headset from your phone. When you disconnect the Bluetooth headset, it still displays in the Paired Bluetooth Device list. You can easily connect it to your phone again.

To disconnect your Bluetooth headset from your phone:

1. Press Menu->Basic->Bluetooth->Paired Bluetooth Device.
2. Select the connected Bluetooth headset.
3. Press the Disconnect soft key.

The Bluetooth headset is disconnected. To connect it to your phone again, press the Connect soft key.

You can delete your Bluetooth headset from your phone. When you delete the Bluetooth headset, it disappears from the Paired Bluetooth Device list. To connect it to your phone again, you need to scan and connect it again.

To delete your Bluetooth headset from your phone:

1. Press Menu->Basic->Bluetooth->Paired Bluetooth Device.
2. Select the Bluetooth headset you want to delete.
3. Press the Option soft key, and then select Delete from the prompt list.

The LCD screen prompts the following warning "Delete the selected item?".

4. Press the OK soft key to confirm the deletion or the Cancel soft key to cancel.

Note

You can also delete all headsets by pressing the **Option** soft key and then select **Delete All**. For more information, refer to the above steps.

If you cannot connect a Bluetooth headset to the phone successfully, we recommend you to delete the Bluetooth headset in the **Paired Bluetooth Device** list (if existed) before pairing it.

DSS Keys

Two types of DSS keys: Line Keys and Programmable Keys. Details will be introduced in the following. The Commander Office T46G IP phone supports 27 line keys.

Line Keys

You can assign predefined functionalities to line keys. You can also define a label for line key feature which will appear on the LCD screen. Line keys allow you to quickly access features such as call return and voice mail. The line key LEDs will indicate the monitored status when the line keys are assigned with particular features, such as BLF. The default key type of line key 1-6 is Line. The default key type of line key 7-27 is N/A, which indicates that this line key provides no functionality until configuration.

To assign functionality to the line key via phone user interface:

1. Press Menu->Call Features->DSS Keys.
2. Select the desired line key, and then press the Enter soft key.
3. Select the desired key type from the Type field.
4. (Optional.) Select the desired key event type from the Key Event field.
5. (Optional.) Select the desired line from the Account ID field.
6. (Optional.) Enter a string that will appear on the LCD screen in the Label field.
7. (Optional.) Enter the corresponding value in the Value field.
8. (Optional.) Enter the corresponding value in the Extension field.
9. Press the Save soft key to accept the change or the Back soft key to cancel.

Line key is configurable via web user interface at the path DSSKey->Line Key.

Note

When the phone is idle, you can also long press the line key to configure it directly on the phone.

You can assign functionalities to 27 line keys. These 27 line keys are indicated on three pages. When you assign functionality to line keys located in line key 1-10, the labels of line keys are indicated on the first page. The following figure shows an example:



When you assign functionality to line key located in line key 11-27, the label of the line key 10-18 are indicated on the second page, and the labels of the line key 19-27 are indicated on the third page. The right bottom line key is used to switch pages. The following figure shows an example:



The following table lists the page icon status:

Icons	Description
	Indicates the current page of line keys.
	Indicates the non-current page of line keys.

You can configure the page icon and page switch key LED to indicate different statuses. This feature is disabled by default. For more information on the page switch key LED status, refer to [LED Instructions](#) on page 5.

The following table lists the page icon status to indicate different statuses:

Icons	Description
	Fast flashing: The BLF monitored user receives an incoming call on the non-current page. Solid red:

	There is a parked call on the non-current page.
	Fast flashing: The line receives an incoming call on the non-current page.

To configure the page icon to indicate status via web user interface:

1. Click on DSSKey->Line Key.
2. Select Enabled from the pull-down list of Enable Page Tips.

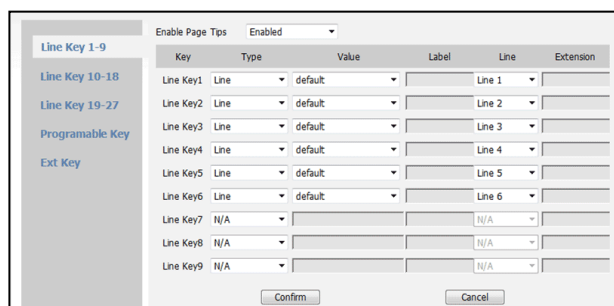

3. Click Confirm to accept the change.

Note

The page icon status is configurable via web user interface only.

Line key features are explained in the following subchapters in detail:

- Line
- Speed Dial
- Voice Mail
- Directed Pickup
- Group Pickup
- DTMF
- Prefix
- Local Group
- XML Group
- XML Brower
- LDAP
- Conference
- Forward
- Transfer
- Hold
- DND
- SMS

- Group Listening
- Zero Touch
- URL
- Keypad Lock
- Directory

For more information, contact your system administrator.

Line

You can use this key feature to accept the incoming calls, place active calls on hold or resume a held call. It performs the same as a hard line key.

Dependencies: Type (Line)

Account ID (the account this feature will be applied to)

Value (Default/Lock/Float)

Usage: When receiving an incoming call, the DSS key LED flashes green:

1. Press the DSS key to accept the incoming call.
2. Press the DSS key to place the active call on hold.
3. Press the DSS key again to resume the held call.

If you select Lock from the Value field, the line keys located in the same position of the other page will be automatically assigned Line feature with Lock filled in the Value field. Then you can use this key on every page. This feature is only applicable to line key 1-9.

If you select Float from the Value field, the phone will automatically switch to the page the line key located, when the line key receives an incoming call.

Speed Dial

You can use this key feature to speed up dialing the numbers often used or hard to remember.

Dependencies: Type (Speed Dial)

Account ID (the account this feature will be applied to)

Label (key label displayed on the LCD screen)

Value (the number you want to dial out)

Usage: Press the DSS key to dial out the number specified in the Value field, using the account selected from the Account ID field.

Voice Mail

You can use this key feature to connect voice mail quickly. For more information, refer to [Voice Mail](#) on page 122.

Dependencies: Type (Key Event)

Key Event (Voice Mail)

Account ID (the account this feature will be applied to)

Label (key label displayed on the LCD screen)

Value (the voice mail access code)

Usage: Press the DSS key to dial out the voice mail access code, you can follow the voice prompt to listen to the voice mails.

Directed Pickup

You can use this key feature to answer someone else's incoming call on the phone.

Dependencies: Type (Key Event)

Key Event (Directed Pickup)

Account ID (the account this feature will be applied to)

Label (key label displayed on the LCD screen)

Value (the directed pickup code followed by the specific phone number)

Usage: Press the DSS key on your phone when the specific phone number receives an incoming call. The call is answered on your phone.

Group Pickup

You can use this key feature to answer incoming calls in a group that is associated with their own group.

Dependencies: Type (Key Event)

Key Event (Group Pickup)

Account ID (the account this feature will be applied to)

Label (key label displayed on the LCD screen)

Value (the group pickup feature code)

Usage: Press the DSS key on your phone when a phone number in the group receives an incoming call. The call is answered on your phone.

DTMF

You can use this key feature to send the specification of arbitrary key sequences via DTMF.

Dependencies: Type (Key Event)

Key Event (DTMF)

Label (key label displayed on the LCD screen)

Value (DTMF sequence)

Note

DTMF sequence can only contain "0-9", "*", "#" and "A-D".

Usage: Press the DSS key during an active call to send the key sequence specified in the Value field.

Prefix

You can use this key feature to add a specified prefix number before the dialed number.

Dependencies: Type (Key Event)

Key Event (Prefix)

Label (key label displayed on the LCD screen)

Value (the prefix number)

Usage: Press the DSS key when the phone is idle, then the phone will enter into the dialing screen and display the prefix number which you specified in the Value field. You can enter other digits and then dial out.

Local Group

You can use this key feature to access the contact group in the local directory quickly. For more information, refer to [Local Directory](#) on page 30.

Dependencies: Type (Key Event)

Key Event (Local Group)

Local Group (the contact group name you want to access)

Label (key label displayed on the LCD screen)

Usage: Press the DSS key to access the contact group specified in the Local Group field.

XML Group

You can use this key feature to access remote group in your corporate directory quickly. You should configure remote phone book in advance. For more information, refer to [Remote Phone Book](#) on page 45.

Dependencies: Type (Key Event)

Key Event (XML Group)

XML Group (the remote group name you want to access if remote phone book is configured)

Label (key label displayed on the LCD screen)

Usage: Press the DSS key to access the remote group specified in the XML Group field.

XML Browser

You can use this key feature to access the XML browser quickly. The XML browser allows you to create custom services which meet your functional requirements on the server. You can customise practical applications, such as weather report, stock information, Google search, etc.

Dependencies: Type (Key Event)

Key Event (XML Browser)

Label (key label displayed on the LCD screen)

Value (the access URL for XML browser)

Usage: Press the DSS key to access the XML browser specified in the Value field.

LDAP

You can use this key feature to access the LDAP search interface quickly.

Dependencies: Type (Key Event)

Key Event (LDAP)

Label (key label displayed on the LCD screen)

Usage:

1. Press the DSS key to access the LDAP search interface.
2. Enter a few continuous characters of the contact name or continuous numbers of the contact number using the keypad.

The contacts whose name or phone number matches the characters entered will appear on the LCD screen.

Conference

You can use this key feature to set up a conference call. For more information, refer to [Conference](#) on page 93.

Dependencies: Type (Key Event)

Key Event (Conference)

Label (key label displayed on the LCD screen)

Value (the number you want to add to the conference)

Usage: Press the DSS key during an active call to set up a conference with the number specified in the Value field.

Note

When leaving the **Value** field blank, the DSS key performs the same as the **Conference** soft key during a call.

Forward

You can use this key feature to forward an incoming call to someone else. For more information, refer to [Call Forward](#) on page 84.

Dependencies: Type (Key Event)

Key Event (Forward)

Label (key label displayed on the LCD screen)

Value (the number you want to forward to)

Usage:

1. Press the DSS key to forward an incoming call to the number specified in the Value field.
2. When call forward is in phone mode, press the DSS key to activate call forward for the phone.

3. When call forward is in custom mode, press the DSS key to access the custom call forward interface. You can activate or deactivate call forward for one or all accounts.

Note

If the **Value** field is left blank, the DSS key performs the same as the **Forward** soft key when receiving an incoming call.

When call forward is activated, the forward key LED will illuminate solid green.

Transfer

You can use this key feature to handle the call differently depending on the transfer mode on DSS key when there is an active call on the phone.

Dependencies: Type (Key Event)

Key Event (Transfer)

Label (key label displayed on the LCD screen)

Value (the number you want to transfer to)

Usage:

- When the transfer mode on DSS key is Blind Transfer, press the DSS key to complete the blind transfer to the number specified in the Value field.
- When the transfer mode on DSS key is Attended Transfer, press the DSS key to dial out the number specified in the Value field, and then perform the attended or semi-attended transfer.
- When the transfer mode on DSS key is New Call, press the DSS key to place a new call to the number specified in the Value field.

Note

Transfer mode via DSS key is configurable via web user interface at the path **Features->Transfer**. For more information on how to configure the transfer mode via DSS key, refer to [Busy Lamp Field \(BLF\)](#) on page 103.

When leaving the **Value** field blank, the DSS key performs the same as the **TRANSFER** key or the **Transfer** soft key during a call. For more information, refer to [Call Transfer](#) on page 91.

Hold

You can use this key feature to place an active call on hold or retrieve a held call.

Dependencies: Type (Key Event)

Key Event (Hold)

Label (key label displayed on the LCD screen)

Usage:

1. Press the DSS key during an active call to place the call on hold.
2. Press the DSS key again to retrieve the held call.

DND

You can use this key feature to activate or deactivate DND. You can also use this key feature to access

the custom DND interface. For more information, refer to [Do Not Disturb \(DND\)](#) on page 80.

Dependencies: Type (Key Event)

Key Event (DND)

Label (key label displayed on the LCD screen)

Usage:

When DND is in phone mode:

1. Press the DSS key to activate DND.
2. Press the DSS key again to deactivate DND.

When DND is in custom mode:

1. Press the DSS key to access the custom DND interface. You can activate or deactivate DND for one or all accounts.

Note

When DND is activated, the DND key LED will illuminate solid green, and the incoming calls will be rejected automatically.

SMS

You can use this key feature to access text message quickly. For more information, refer to [Short Message Service \(SMS\)](#) on page 119.

Dependencies: Type (Key Event)

Key Event (SMS)

Label (key label displayed on the LCD screen)

Usage: Press the DSS key when the phone is idle to access text message.

Group Listening

You can use this key feature to activate the Speakerphone and Handset/Headset mode at the same time. It is suitable for the group conversation which has more than one person at one side. You are able to speak and listen through the handset/headset, meanwhile the others nearby can only listen through the speaker.

Dependencies: Type (Key Event)

Key Event (Group Listening)

Label (key label displayed on the LCD screen)

Usage:

1. During a call, press the DSS key to activate the group listening mode.
You can then speak and listen through the handset/headset, other people at your side can listen through speaker at the same time.
2. Press the DSS key again to deactivate the group listening mode.

Zero Touch

You can use this key feature to configure auto provision and network parameters quickly.

Dependencies: Type (Key Event)

Key Event (Zero Touch)

Label (key label displayed on the LCD screen)

Usage:

1. Press the DSS key to access the zero touch screen.
2. Press the OK soft key within a few seconds.
3. Configure the network parameters in the corresponding fields.
4. Press the Next soft key.
5. Configure the auto provision parameters in the corresponding fields.
6. Press the OK soft key.

The phone will reboot to update configurations.

URL

You can use this key feature to trigger the phone to send an HTTP GET request containing a specific URL.

Dependencies: Type (URL)

Label (key label displayed on the LCD screen)

URL (the URL contained in the HTTP GET request)

Usage: Press the DSS key to trigger the phone to send an HTTP GET request containing the URL specified in the URL field.

Keypad Lock

You can use this key feature to immediately lock the keypad of your phone instead of long pressing . For more information, refer to [Keypad Lock](#) on page 22.

Dependencies: Type (Key Event)

Key Event (Keypad Lock)

Label (key label displayed on the LCD screen)

Usage: Press the DSS key to immediately lock the keypad of your phone instead of long pressing .

Directory

You can use this key feature to easily access frequently used lists. For more information, refer to [Directory](#) on page 29.

Dependencies: Type (Key Event)

Key Event (Directory)

Label (key label displayed on the LCD screen)

Usage: Press the DSS key to immediately access to frequently used lists.

Note

The DSS key performs the same function as the **Directory** soft key when the phone is idle.

Programmable Keys

You can customise the soft keys, navigation keys and function keys.

To customise the programmable keys via web user interface:

1. Click on DSSKey->Programmable Key.
2. Customise specific features for these keys.

Key	Type	Line	Value	Label	Extension
SoftKey 1	History	Local Call Log			
SoftKey 2	Directory	N/A			
SoftKey 3	DND	N/A			
SoftKey 4	Menu	N/A			
Up	History	Local Call Log			
Down	N/A	N/A			
Left	Switch Account	N/A			
Right	Switch Account	N/A			
OK	Status	N/A			
Cancel	N/A	N/A			
HOLD	N/A	N/A			
MUTE	N/A	N/A			
TRAN	Forward	N/A			

3. Click Confirm to accept the change.

Note

Programmable keys are configurable via web user interface only.

Multiple Line Keys per Account

You can configure multiple line keys to associate with an account. This enhances call visualization and simplifies call handling.

If this is the case, the LCD screen resembles the following figure:



Incoming calls to this account will be distributed evenly among the available line keys. Outgoing calls will be distributed similarly.

Your phone can be configured to have a combination of accounts with a single line key and accounts with multiple line keys.

Emergency Number

Public telephone networks in countries around the world have a single emergency telephone number (emergency services number), that allows a caller to contact local emergency services for assistance when necessary. The emergency telephone number may differ from country to country. It is typically a three-digit number so that it can be easily remembered and dialed quickly. Some countries have a different emergency number for each of the different emergency services.

You can specify the emergency telephone numbers on the IP phone for contacting the emergency services in an emergency situation.

Note

Contact your local phone service provider for available emergency numbers in your area.

To specify emergency numbers via web user interface:

1. Click on Features->Phone Lock.
2. Enter the emergency number in the Emergency field.

For multiple emergency numbers, enter “;” between every two numbers. The default emergency numbers are 110, 911 and 120.

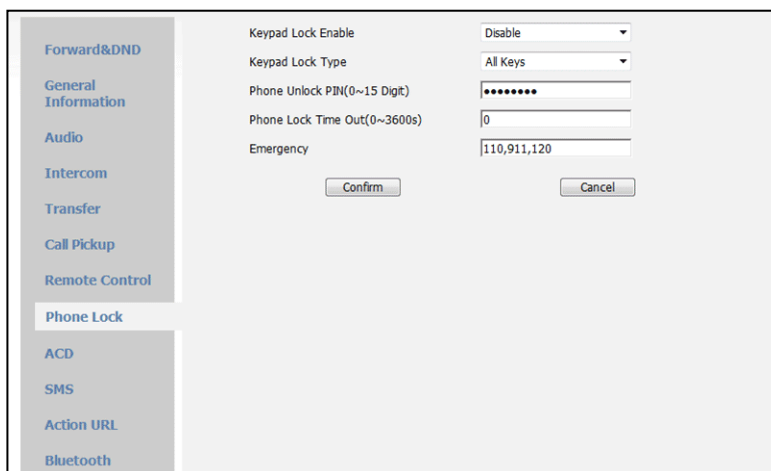

3. Click Confirm to accept the change.

Note

Emergency number is configurable via web user interface only.

Hotline

You can dial a hotline number immediately upon lifting the handset, pressing the speakerphone key or the line key. You can also configure a delay, where the phone will dial out the hotline number automatically after the specified period of time.

To configure the hotline number via phone user interface:

1. Press Menu->Call Features->Others->Hotline.
2. Enter the desired number in the Number field.
3. Enter the delay time in the Hotline Delay 0-10(s) field.



4. Press the Save soft key to accept the change or the Back soft key to cancel.

Hotline is configurable via web user interface at the path Features->General Information.

Basic Call Features

The Commander Office T46G IP phone is designed to be easily used like a regular phone on a public switched telephone network (PSTN). You can place calls, answer calls, transfer a call to someone else, or conduct a conference call.

This chapter provides basic operating instructions for the Commander Office T46G IP phone. Topics include:

- [Placing Calls](#)
- [Answering Calls](#)
- [Ending Calls](#)
- [Redialing Numbers](#)
- [Recent Call In Dialing](#)
- [Auto Answer](#)
- [Auto Redial](#)
- [Call Completion](#)
- [Call Return](#)
- [Call Mute](#)
- [Call Hold/Resume](#)
- [Do Not Disturb \(DND\)](#)
- [Call Forward](#)
- [Call Transfer](#)
- [Call Waiting](#)
- [Conference](#)
- [Call Park](#)
- [Call Pickup](#)
- [Anonymous Call](#)
- [Anonymous Call Rejection](#)

If you require additional information or assistance with your new phone, contact your system administrator.

Placing Calls

You can place a call in three ways using your Commander Office T46G IP phone:

- Using the handset

- Using the speakerphone
- Using the headset

You can also dial the number first, and then choose the way you want to speak to the other party.



You can also search and dial a contact from call history, local directory or remote phone book. For more information, refer to [Contact Management](#) on page 29 and [Call History Management](#) on page 47.

During a call, you can alternate between Speakerphone, Headset, and Handset modes by pressing the Speakerphone key, the HEADSET key, or picking up the handset.

The call duration of active calls is visible on the LCD screen. In the figure below, the call to the number "1000" has lasted 40 seconds.



To place a call using the handset:

1. Pick up the handset.
2. Enter the desired number using the keypad.
3. Press , , or the Send soft key.

The # key is configured as a send key by default.







Note

You can also dial using the SIP URI or IP address. To obtain the IP address of a phone, press the **OK** key. The maximum SIP URI or IP address length is 32 characters. For example, SIP URI: 3606@sip.com, IP: 192.168.1.15.

Your phone may not support direct IP dialing. Contact your system administrator for more information.







To place a call using the hands-free speakerphone mode:

Do one of the following:

- With the handset on-hook, press  or the line key to obtain a dial tone.
Enter the desired number using the keypad.
Press ,  or the Send soft key.
- With the handset on-hook, enter the desired number using the keypad.
Press , ,  or the Send soft key.

To place a call using the headset:

Do one of the following:





- With the optional headset connected, press  to activate the headset mode.
Press the line key to obtain a dial tone.
Enter the desired number using the keypad.
Press , , or the Send soft key.
- With the optional headset connected, press  to activate the headset mode.
Enter the desired number using the keypad.
Press , , or the Send soft key.



Note

To permanently use the headset mode, refer to [Headset Prior](#) on page 49.

To place multiple calls:

You can have more than one call on your Commander Office T46G IP phone. To place a new call during an active call, do one of the following:

- Press the line key. The active call is placed on hold.
Enter the desired number using the keypad.
Press , , or the Send soft key.
- Press  or the Hold soft key to place the original call on hold.
Press the New Call soft key.
Enter the desired number using the keypad.
Press , , or the Send soft key.

You can press  or  to switch between calls, and then press the Resume soft key to retrieve the desired call.

Answering Calls

When you are not in another call, you can answer a call in three ways:

- Using the handset
- Using the speakerphone

- Using the headset

Note

You can ignore incoming calls by pressing the **X** key, the **Reject** soft key or the **Silence** soft key. You can also activate Do Not Disturb mode to ignore the incoming calls without ring on your phone. For more information, refer to [Do Not Disturb \(DND\)](#) on page 80.

You can forward incoming calls to someone else by pressing the **Forward** soft key. For more information, refer to [Call Forward](#) on page 84.

Answering When Not in Another Call

Call duration and destination will always appear on the LCD screen for the active call.

To answer a call using the handset:

1. Pick up the handset.

To answer a call using the hands-free speakerphone mode:

Do one of the following:

- Press  .
- With the handset on-hook and the headset mode deactivated, press the Answer soft key.
- With the handset on-hook and the headset mode deactivated, press the line key (the line key LED flashes green).



To answer a call using the headset:

Do one of the following:

- Press  .
- With the headset mode activated, press the Answer soft key.
- With the headset mode activated, press the line key (the line key LED flashes green).

Answering When in Another Call

If you have an active call, and an incoming call arrives on the phone, do one of the following:

- Press the Answer soft key.
The incoming call is answered and the original call is placed on hold.
- Press  to access the new call.
Press  or the Answer soft key.
The incoming call is answered and the original call is placed on hold.

Ending Calls

To end a call:

Do one of the following:

- If you are using the handset, press the End Call soft key or hang up the handset.
- If you are using the headset, press the End Call soft key.
- If you are using the speakerphone, press  or the End Call soft key.

Note





To end a call placed on hold, you can press the **End Call** soft key to end the call directly, or press the **Resume** soft key to resume the call before ending it.

Redialing Numbers

To redial the last dialed number from your phone:

1. Press  twice.
A call to your last dialed number is attempted.

To redial a previously dialed number from your phone:

1. Press  when the phone is idle.
2. Press  or  to select the desired entry from the placed calls list, and then press  or the Send soft key.

Recent Call In Dialing

To view the placed calls list when the phone is in the pre-dialing interface, you should enable recent call in dialing in advance.

To enable recent call in dialing via web user interface:

1. Click on Directory->Setting.

2. Select Enabled from the pull-down list of Recent Call In Dialing.

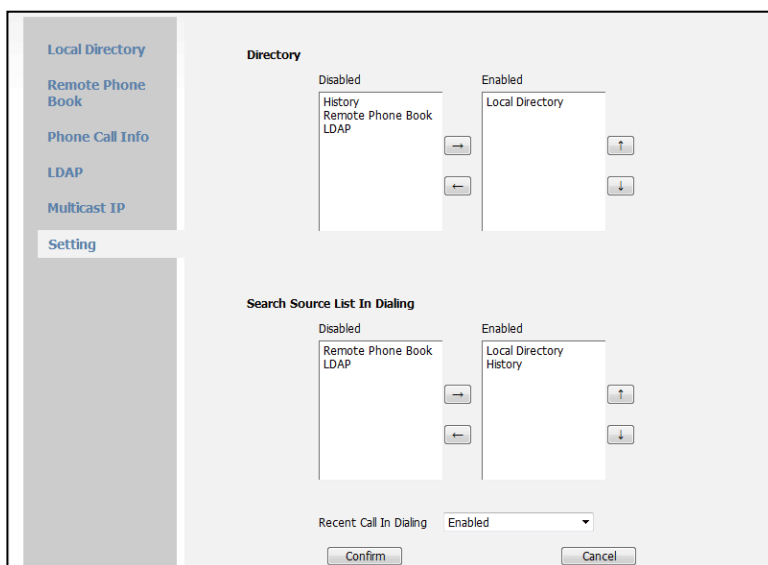

3. Click Confirm to accept the change.

Note

Recent call in dialing is configurable via web user interface only.

To view placed calls list when the phone is in the pre-dialing interface:

1. Pick up the handset, press the speakerphone key or press the line key.

The LCD screen displays the placed calls list.

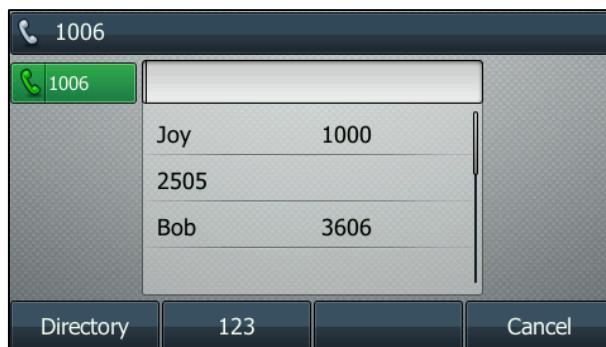

Auto Answer

You can use auto answer to automatically answer an incoming call on a line. Auto answer is configurable on a per-line basis.

To configure auto answer via phone user interface:

1. Press Menu->Call Features->Auto Answer.
2. Select the desired line and then press the Enter soft key.
3. Press or , or the Switch soft key to select Enabled from the Auto Answer field.

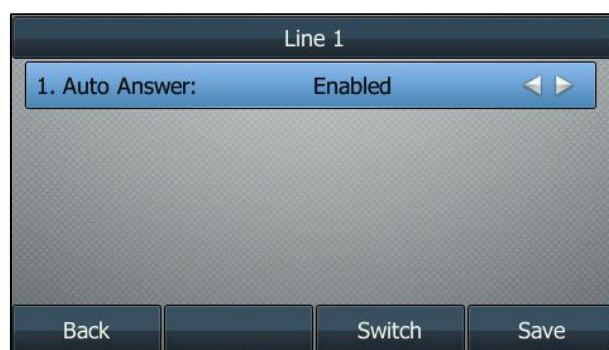

4. Press the Save soft key to accept the change or the Back soft key to cancel.

The  icon appears on the LCD screen.



Auto answer is configurable via web user interface at the path Account->Basic.



Note

Auto answer is only applicable when there is no other call in progress on the phone.

Auto Redial

You can enable auto redial to redial the phone number automatically when the called party is busy. You can also configure the times settings for auto redial and the time to wait between redial attempts.

To configure auto redial via phone user interface:

1. Press Menu->Call Features->Others->Auto Redial.
2. Press  or , or the Switch soft key to select Enabled from the Auto Redial field.
3. Enter the desired time (in seconds) in the Redial Interval field.
The default time interval (in seconds) is 10.
4. Enter the desired times in the Redial Times field.
The default value is 10.

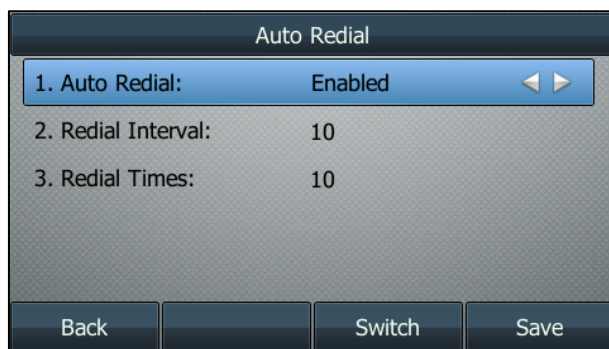

5. Press the Save soft key to accept the change or the Back soft key to cancel.

Auto redial is configurable via web user interface at the path Features->General Information.

To use auto redial:

When the called party is busy, the LCD screen prompts the following:

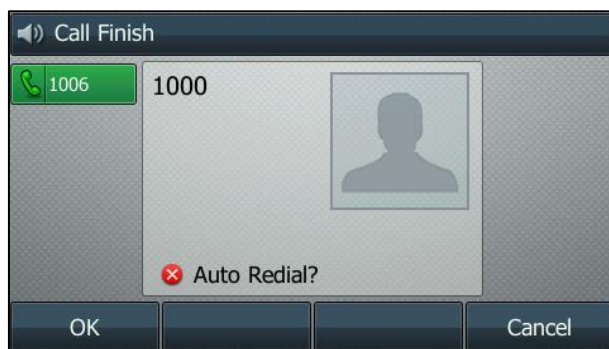

1. Press the OK soft key to activate auto redial. The following prompt will appear on the LCD screen of the phone:

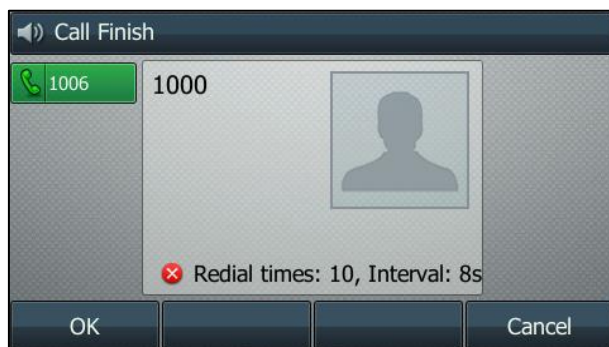

2. Wait for a period of time or press the OK soft key to redial the phone number.

The phone will retry as many times as configured until the called party is idle.

Call Completion

You can use call completion to notify the caller who failed to reach a desired callee when the callee becomes available to receive a call.

To configure call completion via phone user interface:

1. Press Menu->Call Features->Others->Call Completion.
2. Press ◀ or ▶, or the Switch soft key to select Enabled from the Call Completion field.

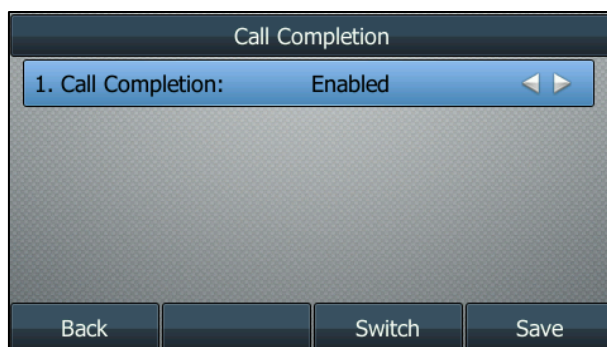

3. Press the Save soft key to accept the change or the Back soft key to cancel.

Call completion is configurable via web user interface at the path Features->General Information.

To use call completion:

When the called party is busy, the following prompt will appear on the LCD screen of the phone:

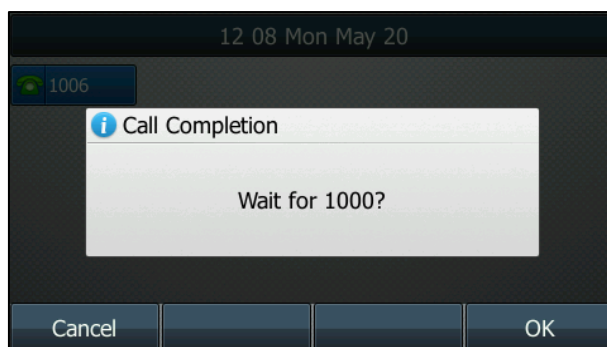

1. Press the OK soft key, the phone returns to the idle screen and call completion is activated.

- When the called party becomes idle, the LCD screen prompts the following:

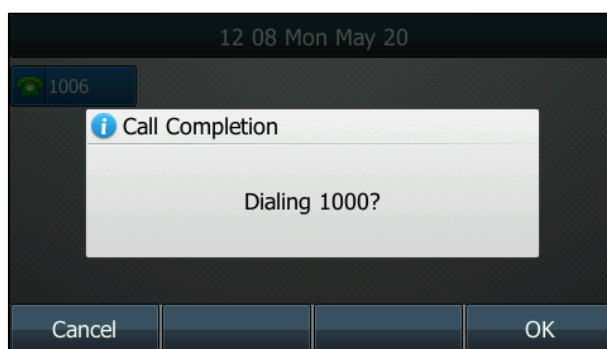

- Press the OK soft key to redial the number.

Note

Call completion is not available on all servers. For more information, contact your system administrator.

Call Return

You can press a call return key to place a call back to the last incoming call.

To configure a call return key via phone user interface:

- Press Menu->Call Features->DSS Keys.
- Select a desired DSS key.
- Press ◀ or ▶, or the Switch soft key to select Key Event from the Type field.
- Press ◀ or ▶, or the Switch soft key to select Call Return from the Key Event field.
- (Optional.) Enter a string that will appear on the LCD screen in the Label field.

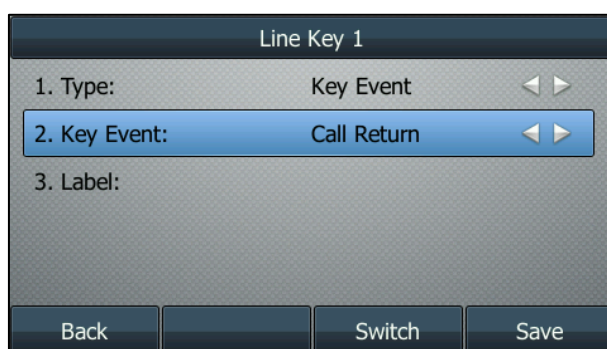

- Press the Save soft key to accept the change or the Back soft key to cancel.

Call return key is configurable via web user interface at the path DSSKey->Line key.

Call Mute

You can mute the microphone of the active audio device during an active call, and then the other party

cannot hear you.

To mute a call:

1. Press  during an active call.

The LCD screen indicates that the call is on mute. The mute key LED illuminates solid red when the call is on mute.

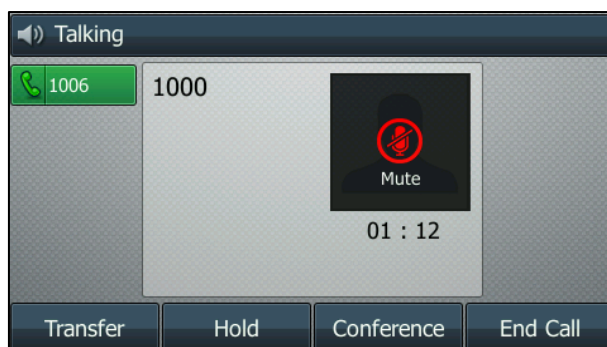

To un-mute a call:

1. Press  again to un-mute the call.

Call Hold/Resume

You can place an active call on hold. Only one active call can be in progress at any time. Other calls can be made and received while placing the original call on hold. When you place a call on hold, your IP PBX may play music on hold to the other party while waiting.

To place a call on hold:

1. Press  or the Hold soft key during a call.

The LCD screen indicates that the call is on hold.

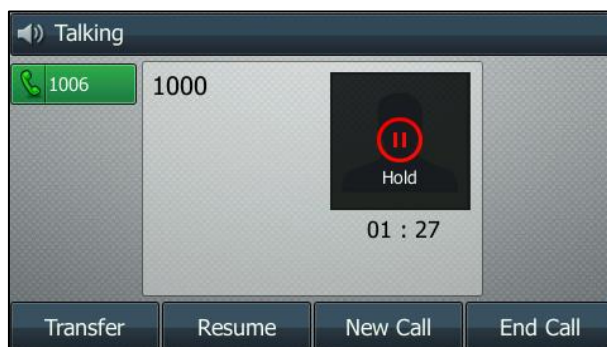



The line key LED flashes green. The phone will beep softly every 30 seconds to remind you that you still have a call on hold.

To resume a held call:

1. Press  or the Resume soft key.

Multiple Calls on Hold:

If multiple calls are placed on hold, do one of the following:

- Press  or  to switch between the calls, and then press the Resume soft key to retrieve the desired call.
- Press the corresponding line key to retrieve the call.

If more than two calls are on hold, a numbered prompt appears on the LCD screen, for example "2/4", indicating that this is the second call out of four calls.

Do Not Disturb (DND)

You can use DND to reject incoming calls automatically on the phone. Callers will receive a busy message.

You can enable/disable DND for the phone system, or you can customise DND for each or all accounts.

Two DND modes:

- Phone (default): DND is effective for the phone system.
- Custom: DND can be configured for each or all accounts.

You can receive incoming calls from authorised numbers when DND is enabled.

To configure the DND mode via web user interface:

1. Click on Features->Forward & DND.

- In the DND block, mark the desired radio box in the Mode field.

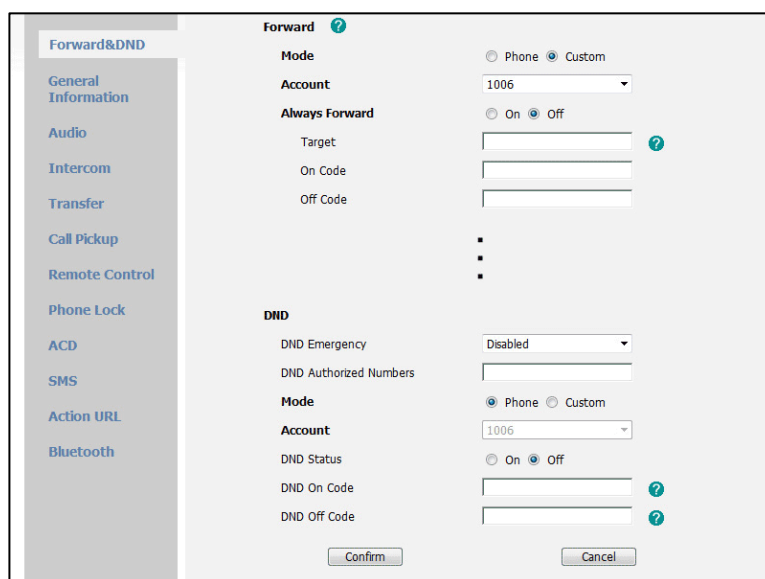

- Click Confirm to accept the change.

Note

DND mode is configurable via web user interface only.

To activate DND in phone mode:

- Press the DND soft key when the phone is idle.

The  icon on the idle screen indicates that DND is enabled.

Incoming calls will be rejected automatically and "n New Missed Call(s)" ("n" indicates the number of the missed calls) will appear on the LCD screen.

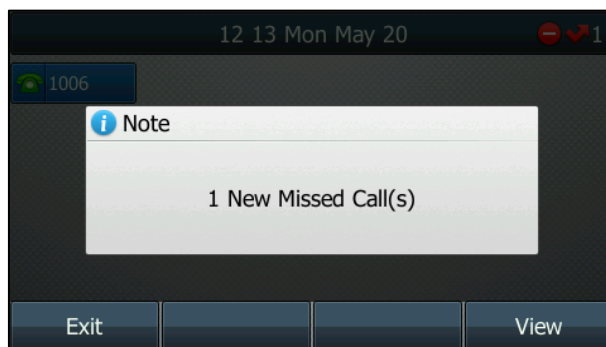





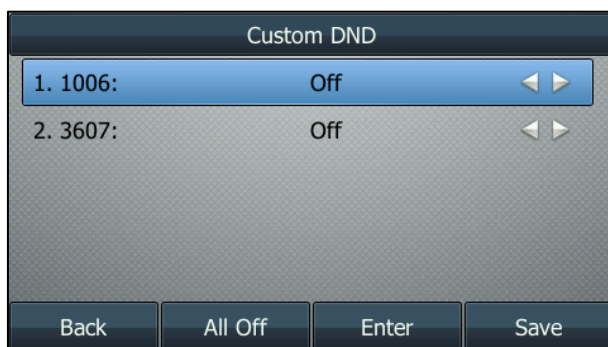

To activate DND in custom mode for a specific account:

- Press the DND soft key when the phone is idle.

The LCD screen displays a list of accounts on the phone.



2. Press  or  to select the desired account.
3. Press  or  soft key to select On to activate DND.
4. Press the Save soft key to accept the change.

The  icon appears on the idle screen, and the associated line icon changes to .

Incoming calls on the specific line will be rejected automatically, and the LCD screen will prompt "n New Missed Call(s)" ("n" indicates the number of the missed calls).

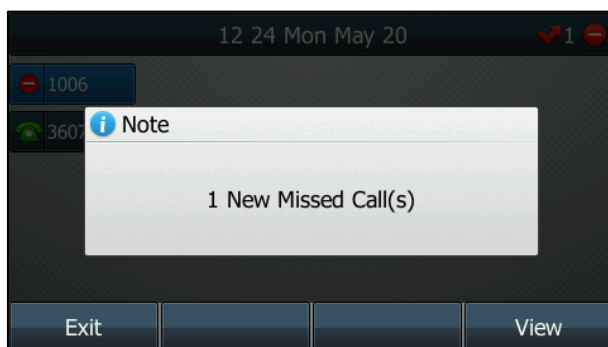

To activate DND in custom mode for all accounts:

1. Press the DND soft key when the phone is idle.

The LCD screen displays a list of accounts registered on the phone.

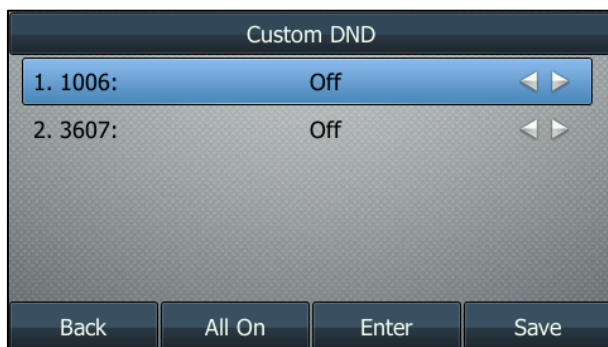

2. Press the All On soft key to activate DND for all accounts.
3. Press the Save soft key to accept the change.

The  icon appears on the idle screen, and all line icons change to .

Incoming calls will be rejected automatically, and the LCD screen will prompt "n New Missed Call(s)" ("n" indicates the number of the missed calls).

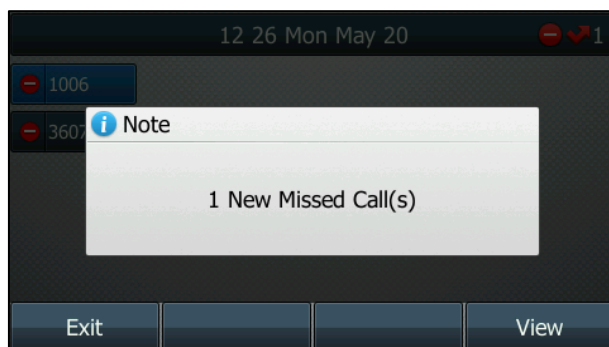

Note

The prompt message displays only if Missed Call Log for the line is enabled. Missed call log is configurable via web user interface at the path **Account->Basic**.
Do not disturb is local to the phone, and may be overridden by the server settings. For more information, contact your system administrator.

To configure the DND authorised numbers via web user interface:

1. Click on Features->Forward & DND.
2. Select Enabled from the pull-down list of DND Emergency.
3. Enter the numbers in the DND Authorised Numbers field.
For multiple numbers, enter ";" between every two numbers.

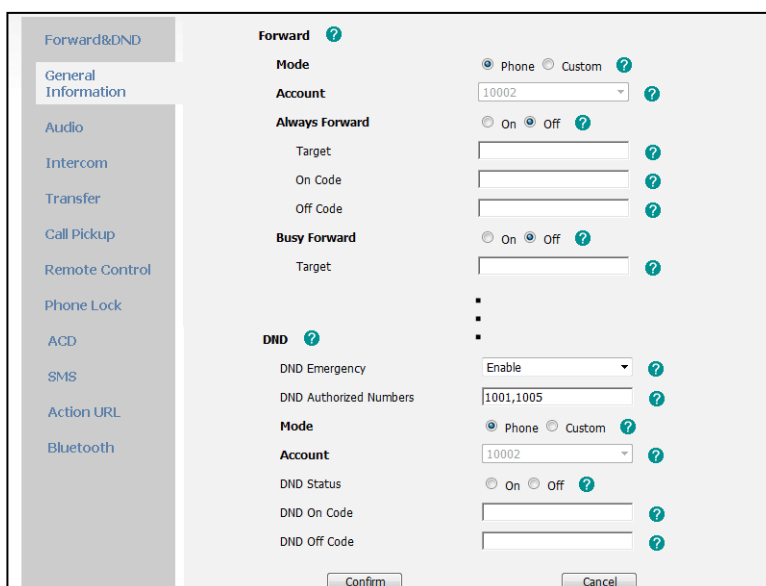

4. Click Confirm to accept the change.

When DND is enabled on the phone, the phone can still receive incoming calls from the numbers specified in the DND Authorised Numbers field.

Note

DND authorised number is configurable via web user interface only.

Call Forward

You can configure your phone to forward incoming calls to another party by the static forwarding. You can also forward calls while your phone is ringing, refer to the dynamic forwarding.

Static Forwarding

Three types of static forwarding:

- Always Forward: Incoming calls are immediately forwarded.
- Busy Forward: Incoming calls are immediately forwarded if the phone is busy.
- No Answer Forward: Incoming calls are forwarded if not answered after a period of time.

You can enable/disable call forward for the phone system, or you can customise call forward for each or all accounts. Two call forward modes:

- Phone (default): Call forward is effective for the phone system.
- Custom: Call forward can be configured for each or all accounts.

To configure the call forward mode via web user interface:

1. Click on Features->Forward & DND.
2. In the Forward block, mark the desired radio box in the Mode field.





3. Click Confirm to accept the change.

Note



Call forward mode is configurable via web user interface only.

To enable call forward in phone mode:

1. Press Menu->Call Features->Call Forward.

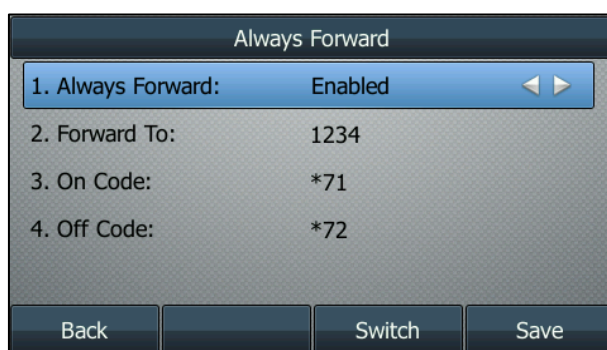
2. Press  or  to select the desired forwarding type, and then press the Enter soft key.
3. Depending on your selection:
 - a.) If you select Always Forward:
 - 1) Press  or  , or the Switch soft key to select Enabled from the Always Forward field.
 - 2) Enter the destination number you want to forward all incoming calls to in the Forward To field.
 - 3) (Optional.) Enter the always forward on code or off code respectively in the On Code or Off Code field.



- b.) If you select Busy Forward:
 - 1) Press  or  , or the Switch soft key to select Enabled from the Busy Forward field.
 - 2) Enter the destination number you want to forward incoming calls to when the phone is busy in the Forward To field.

- 3) (Optional.) Enter the busy forward on code or off code respectively in the On Code or Off Code field.



c.) If you select No Answer Forward:

- 1) Press ◀ or ▶ , or the Switch soft key to select Enabled from the No Answer Forward field.
- 2) Enter the destination number you want to forward unanswered incoming calls to in the Forward To field.
- 3) Press ◀ or ▶ , or the Switch soft key to select the ring time to wait before forwarding from the After Ring Time field.
The default ring time is 12 seconds.
- 4) (Optional.) Enter the no answer forward on code or off code respectively in the On Code or Off Code field.

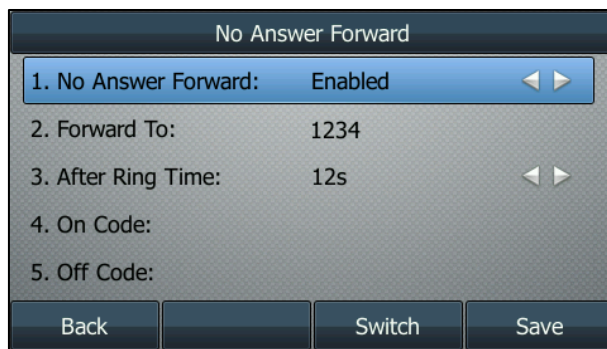

4. Press the Save soft key to accept the change or the Back soft key to cancel.

The  icon on the idle screen indicates the call forward is enabled.

To enable call forward in custom mode:

1. Press Menu->Call Features->Call Forward.
2. Press ▲ or ▼ to select the desired account, and then press the Enter soft key.
3. Press ▲ or ▼ to select the desired forwarding type, and then press the Enter soft key.
4. Depending on your selection:
 - a.) If you select Always Forward, you can enable it for a specific account.
 - 1) Press ◀ or ▶ , or the Switch soft key to select Enabled from the Always Forward

field.

- 2) Enter the destination number you want to forward all incoming calls to in the Forward To field.
- 3) (Optional.) Enter the always forward on code or off code respectively in the On Code or Off Code field.



You can also enable always forward for all accounts. After always forward was enabled for a specific account, do the following:

- 1) Press or to highlight the Always Forward field.
- 2) Press the All Lines soft key.

The LCD screen prompts “Copy to all lines?”.

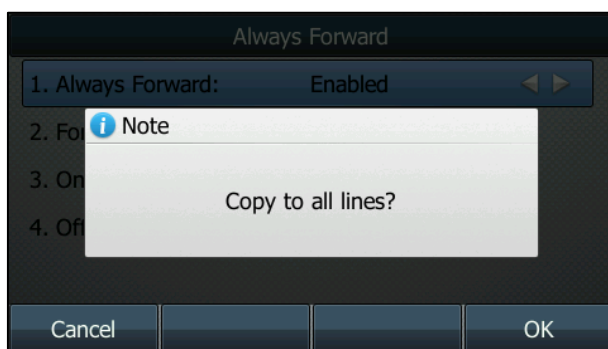

- 3) Press the OK soft key to accept the change or the Cancel soft key to cancel.

b.) If you select Busy Forward, you can enable it for a specific account.

- 1) Press or , or the Switch soft key to select Enabled from the Busy Forward field.
- 2) Enter the destination number you want to forward incoming calls to when the phone is busy in the Forward To field.

- 3) (Optional.) Enter the busy forward on code or off code respectively in the On Code or Off Code field.

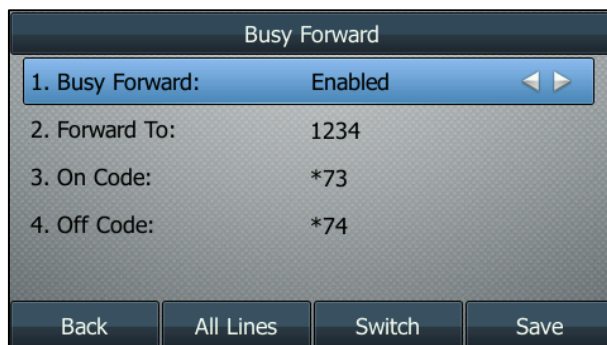

You can also enable busy forward for all accounts. After busy forward was enabled for a specific account, do the following:

- 1) Press or to highlight the Busy Forward field.
- 2) Press the All Lines soft key.

The LCD screen prompts “Copy to all lines?”.

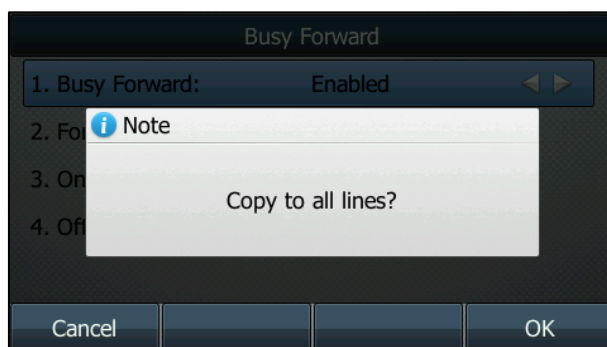



- 3) Press the OK soft key to accept the change or the Cancel soft key to cancel.
- c.) If you select No Answer Forward, you can enable it for a specific account.
- 1) Press or , or the Switch soft key to select Enabled from the No Answer Forward field.
 - 2) Enter the destination number you want to forward unanswered incoming calls to in the Forward To field.
 - 3) Press or , or the Switch soft key to select the ring time to wait before forwarding from the After Ring Time field.

The default ring time is 12 seconds.

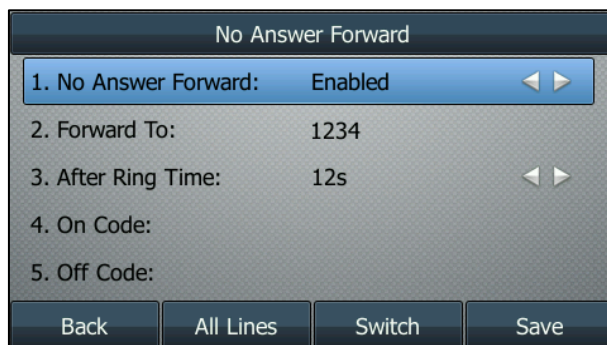
- 4) (Optional.) Enter the no answer forward on code or off code respectively in the On Code or Off Code field.





You can also enable no answer forward for all accounts. After no answer forward was enabled for a specific account, do the following:

- 1) Press  or  to highlight the No Answer Forward field.
- 2) Press the All Lines soft key.

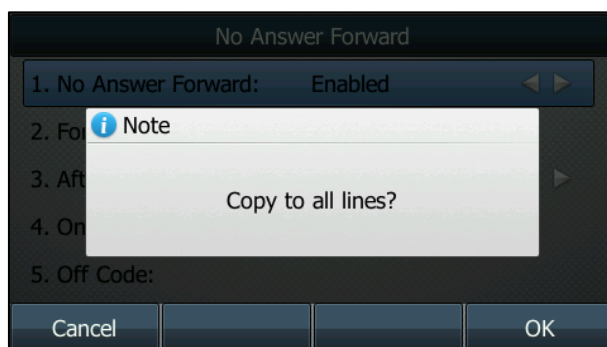
The LCD screen prompts “Copy to all lines?”.



- 3) Press the OK soft key to accept the change or the Cancel soft key to cancel.
5. Press the Save soft key to accept the change or the Back soft key to cancel.

The  icon appears on the idle screen, and the associated line icon changes to .

Call forward is configurable via web user interface at the path Features->Forward & DND.





Note

You can also enter the SIP URL or IP address in the **Forward To** field. For more information on using the SIP URL or IP address, refer to [Placing Calls](#) on page 69.







Call forward is local to the phone, and may be overridden by the server settings. Call forward on code or off code may be different between servers. For more information, contact your system administrator.

To disable call forward in phone mode:

Do one of the following:

- Press  when the phone is idle.
- Press Menu->Call Features->Call Forward.
Press  or  to select the desired forwarding type, then press the Enter soft key.
Press  or , or the Switch soft key to select Disabled to disable the call forward.
Press the Save soft key to accept the change.

To disable call forward in custom mode for a specific account:



1. Press Menu->Call Features->Call Forward or press  when the phone is idle.
2. Press  or  to select the desired account, then press the Enter soft key.
3. Press  or  to select the desired forwarding type, then press the Enter soft key.
4. Press  or , or the Switch soft key to select Disabled to disable the call forward.
5. Press the Save soft key to accept the change.

Dynamic Forwarding

To forward an incoming call to another party:

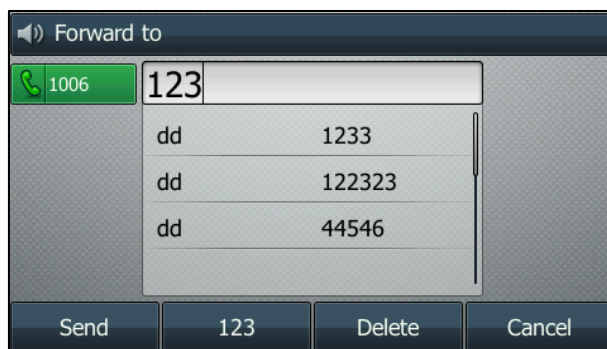
1. When the phone is ringing, press the Forward soft key.
2. Enter the number you want to forward the incoming call to.



3. Press , , or the Send soft key.
The LCD screen prompts a call forward message.

Call Transfer

You can transfer a call to another party in one of the three ways:

- Blind Transfer: Transfer a call directly to another party without consulting.
- Semi-Attended Transfer: Transfer a call when the target phone is ringing.
- Attended Transfer: Transfer a call with prior consulting.





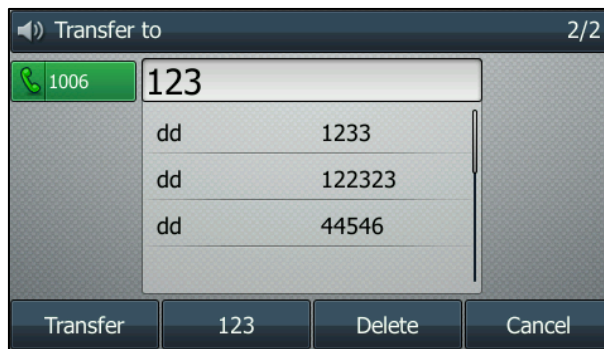

To perform a blind transfer:

1. Press  or the Transfer soft key during a call.
2. Enter the number you want to transfer the call to.









3. Press  to complete the transfer.
Then the call is connected to the number to which you are transferring.

To perform a semi-attended transfer:

1. Press  or the Transfer soft key during a call.
2. Do one of the following:
 - Press the Directory soft key, and then select Local Directory. Select the desired group and search for the contact (Directory should be configured in advance. Refer to [Directory](#) on page 29 for more information).
 - Press the Directory soft key, and then select Local Call log. Select the desired list and press  or  to select the entry (Directory should be configured in advance. Refer to [Directory](#) on page 29 for more information).
 - Press the Directory soft key, and then select Remote Phone Book. Select the desired group and search for the contact (Directory should be configured in advance. Refer to [Directory](#) on page 29 and [Remote Phone Book](#) on page 45 for more information).
3. Press  or  to dial out.
4. Press  or the Transfer soft key to complete the transfer when receiving ringback.

To perform an attended transfer:

1. Press  or the Transfer soft key during a call.
2. Do one of the following:
 - Enter the number you want to transfer the call to.
 - Press the Directory soft key, and then select Local Directory. Select the desired group and search for the contact (Directory should be configured in advance. Refer to [Directory](#) on page 29 for more information).
 - Press the Directory soft key, and then select Local Call log. Select the desired list and press  or  to select the entry (Directory should be configured in advance. Refer to [Directory](#) on page 29 for more information).
 - Press the Directory soft key, and then select Remote Phone Book. Select the desired group and search for the contact (Directory should be configured in advance. Refer to [Directory](#) on page 29 and [Remote Phone Book](#) on page 45 for more information).
3. Press  or  to dial out.
4. After the party answers the call, press  or the Transfer soft key to complete the transfer.





If you are using a handset, the transfer can be completed by hanging up the handset.

You can cancel the transfer before the call is connected by pressing the Cancel soft key.

Call Waiting

You can enable or disable call waiting on the phone. If call waiting is enabled, you can receive another call when there is an active call on the phone. Otherwise, another incoming call is automatically rejected by the phone with a busy message when there is an active call on the phone. You can also enable or disable the phone to play a warning tone when receiving another call.

To configure call waiting via phone user interface:

1. Press Menu->Call Features->Call Waiting.
2. Press  or , or the Switch soft key to select Enabled from the Call Waiting field.
3. Press  or , or the Switch soft key to select Enabled from the Play Tone field.

- (Optional.) Enter the call waiting on code or off code respectively in the On Code or Off Code field.

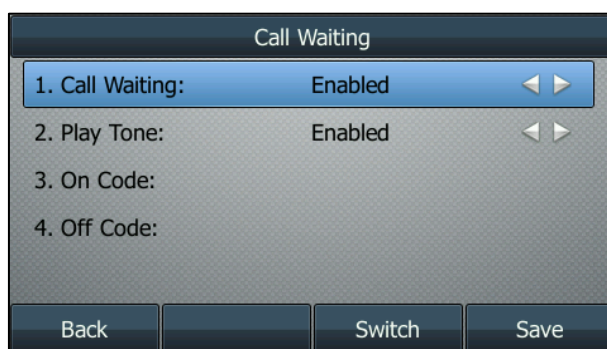

- Press the Save soft key to accept the change or the Back soft key to cancel.

Call waiting is configurable via web user interface at the path Features->General Information.

Conference

You can create a conference with two parties using the phone's local conference. You can create a conference between an active call and a call on hold by pressing the Conference soft key. The Commander Office T46G also supports network conference.



Note

Network conference is not available on all servers. For more information, contact your system administrator.

Local Conference

The Commander Office T46G IP phone supports up to 3 parties (including yourself) in a conference call. This is the default method of conference called Local Conference.

To set up a local conference call:

- Place a call to the first party.
- When the first party answers the call, press the Conference soft key to place a new call.
The active call is placed on hold.
- Enter the number of the second party and press , , or the Send soft key.

4. When the second party answers the call, press the Conference soft key again to join all parties in the conference.



To join two calls in a conference:

1. Place two calls using two different accounts on the phone (for example, place the first call using account 1, and then place the second call using account 2).
2. Press or to select the call for conference and make sure the call is active (for example, select the call on account 1).
3. Press the Conference soft key to join the two calls in the conference on the selected account.

During the conference call, you can do the following:

- Press or the Hold soft key to place the conference on hold.
- Press the Split soft key to split the conference call into two individual calls.
- Press the Manage soft key, and then press or to select the desired party:
 - Press the Far Mute soft key to forbid the party from speaking.
 - Press the Remove soft key to remove the party from the conference call.
 - Press the Back soft key to return to the previous interface.
- Press to mute the conference call.
- Press the End Call soft key to drop the conference call.

Network Conference

You can use network conference feature on the Commander Office T46G IP phone to conduct a conference with multiple participants.

This feature allows you to perform the following:

- Join two calls together into a conference call.
- Invite another party into an active conference call.

To use this feature, contact your system administrator for the network conference URI in advance.

To configure network conference via web user interface:

1. Click on Account->Advanced.
2. Select Network Conference from the pull-down list of Conference Type.
3. Enter the conference URI (e.g., conference@example.com) in the Conference URI field.

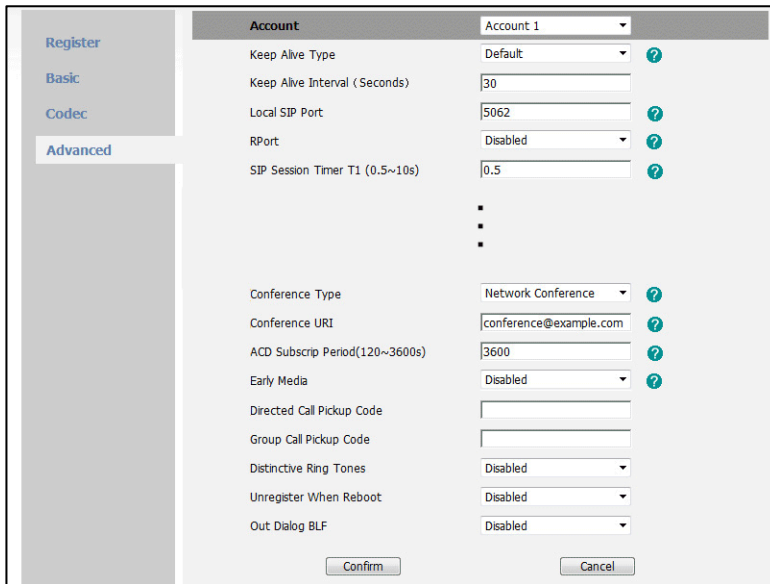





4. Click Confirm to accept the change.

Note

Network conference is configurable via web user interface only.

To set up a network conference call:

1. Place a call to the first party.
2. Press the Conference soft key to place a new call.
The active call is placed on hold.
3. Enter the number of the second party and press , , or the Send soft key.
4. When the second party answers the call, press the Conference soft key to add the second party to the conference.
5. Press the Conference soft key to place a new call.
The conference is placed on hold.
6. Enter the number of the new party and then press , , or the Send soft key.
7. When the new party answers the call, press the Conference soft key to add the new party to the conference.
8. Repeat steps 5 to 7 until you have added all intended parties.

The procedures to set up a network conference call on specific servers may be different from introduced above. Contact your system administrator for more information.

Call Park

You can use call park to place a call on hold, and then retrieve the call from another phone in the system (for example, a phone in another office or conference room). You can park an active call by pressing the call park key on the phone. If the call is parked successfully, the response is either a voice prompt confirming that the call was parked, or a visible prompt on the LCD screen.

Note

Call park is not available on all servers. Contact your system administrator for more information.

To configure a call park key via phone user interface:

1. Press Menu->Call Features->DSS Keys.
2. Select the desired DSS key.
3. Press ◀ or ▶, or the Switch soft key to select Key Event from the Type field.
4. Press ◀ or ▶, or the Switch soft key to select Call Park from the Key Event field.
5. Press ◀ or ▶, or the Switch soft key to select the desired line from the Account ID field.
6. Enter the call park code in the Value field.
7. (Optional.) Enter the string that will appear on the LCD screen in the Label field.

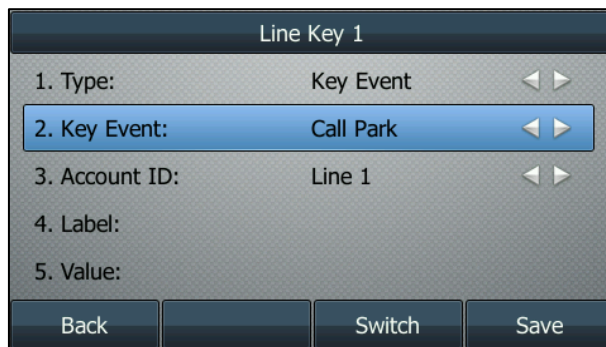

8. Press the Save soft key to accept the change or the Back soft key to cancel.

Call park key is configurable via web user interface at the path DSSKey->Line Key.

To use call park:

1. User on phone A places a call to phone B.
2. User on phone A wants to take the call in a conference room for privacy, then presses the call park key on phone A.
3. User on phone A walks to an available conference room where the phone is designated as phone C. The user dials the call park retrieve code to retrieve the parked call.
The system establishes call between phone C and B.

Note

The call park code and call park retrieve code are predefined on the system server. Contact your system administrator for more information.

If the parked call is not retrieved within a period of time assigned by the system, the phone performing call park feature will receive call back.

Call Pickup

You can use call pickup to answer someone else's incoming call on the phone. The Commander Office T46G IP phone supports directed call pickup and group call pickup. Directed call pickup is used for picking up a call that is ringing at a specific phone number. Group call pickup is used for picking up a call that is ringing at any phone number in the group. The pickup group should be predefined, contact your system administrator for more information.

You can pick up an incoming call by using the DPickup/GPickup soft key. To use call pickup, you need to configure the call pickup code beforehand on a global or per-line basis via web user interface.

Note

If there are many incoming calls at the same time, pressing the **GPickup** soft key on the phone will pick up the call that rings first.

Directed Call Pickup

To enable directed call pickup and configure the directed call pickup code on a global basis via web user interface:

1. Click on Features->Call Pickup.
2. Select Enabled from the pull-down list of Directed Call Pickup.
3. Enter the directed call pickup code in the Directed Call Pickup Code field.

4. Click Confirm to accept the change.

To configure the directed call pickup code on a per-line basis via web user interface:

1. Click on Account.
2. Select the desired account from the pull-down list of Account.
3. Click on Advanced.
4. Enter the directed call pickup code in the Directed Call Pickup Code field.

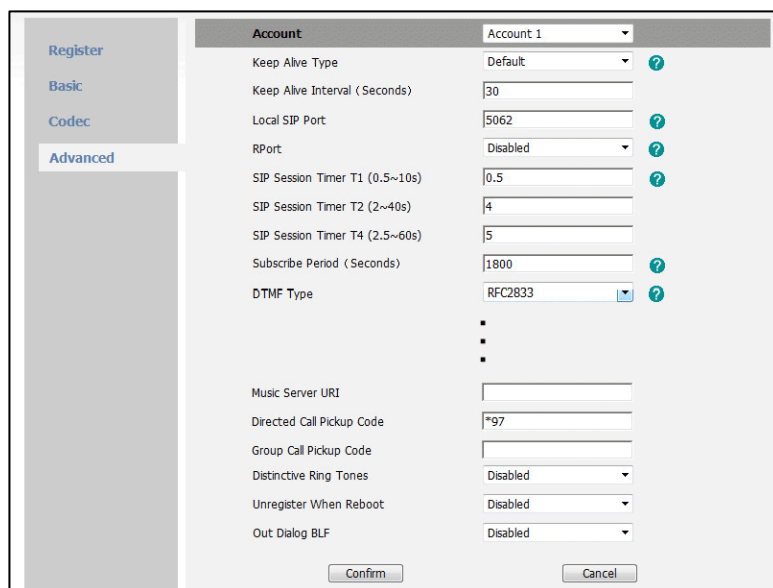

5. Click Confirm to accept the change.

To pick up a call directly:

1. Pick up the handset.
2. The DPickup soft key appears on the LCD screen.

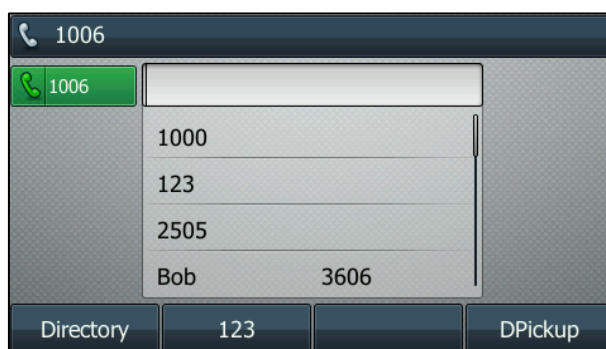

3. Press the DPickup soft key on your phone when a phone receives an incoming call.
4. Enter the phone number which receives an incoming call.
5. Press the DPickup soft key again.

The call is answered on your phone.

You can also configure a DSS key as a directed pickup key via phone user interface or web user interface. You can pick up a call by pressing the directed pickup key directly.

Group Call Pickup

To enable the group call pickup and configure the group call pickup code on a global basis via web user interface:

1. Click on Features->Call Pickup.
2. Select Enabled from the pull-down list of Group Call Pickup.

3. Enter the group call pickup code in the Group Call Pickup Code field.

The screenshot shows the 'Call Pickup' configuration page. On the left is a sidebar with the following menu items: Forward&DND, General Information, Audio, Intercom, Transfer, Call Pickup (highlighted), Remote Control, Phone Lock, ACD, SMS, Action URL, and Bluetooth. The main content area is titled 'Call Pickup' and contains the following settings:

Directed Call Pickup	Disabled
Directed Call Pickup Code	
Group Call Pickup	Enabled
Group Call Pickup Code	98
Visual Alert for BLF Pickup	Disabled
Audio Alert for BLF Pickup	Disabled

At the bottom of the main content area are two buttons: 'Confirm' and 'Cancel'.

4. Click Confirm to accept the change.

To configure the group call pickup code on a per-line basis via web user interface:

1. Click on Account.
2. Select the desired account from the pull-down list of Account.
3. Click on Advanced.

- Enter the group call pickup code in the Group Call Pickup Code field.

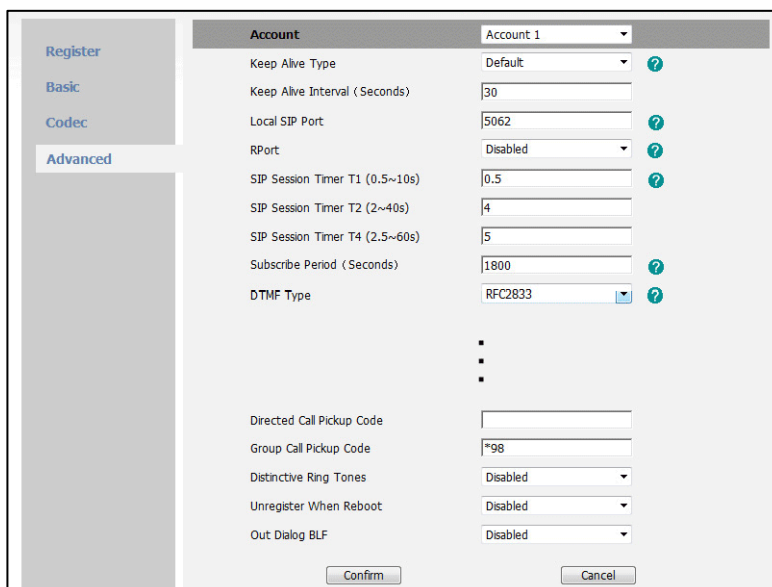

- Click Confirm to accept the change.

To pick up a call in the group:

- Pick up the handset.
- The GPickup soft key appears on the LCD screen.

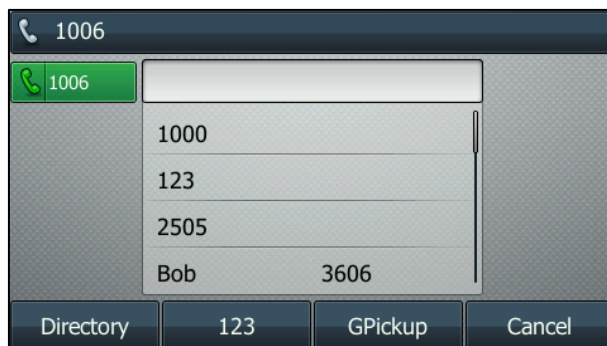

- Press the GPickup soft key on your phone when a phone in the group receives an incoming call.

The call is answered on your phone.

You can also configure a DSS key as group pickup key via phone user interface or web user interface.

You can pick up a call by pressing the group pickup key directly.

Note

The directed call pickup code and group call pickup code are predefined on the system server. Contact your system administrator for more information.

The call pickup code configured on a per-line basis takes precedence over that configured on a global basis.

Anonymous Call

Note

Activating Anonymous call will prevent your phone from making outbound calls. Please do not activate this feature if you wish to make outbound calls. If you wish to make an anonymous call please use the feature access codes.

To configure anonymous call via phone user interface:

1. Press Menu->Call Features->Anonymous.
2. Select the desired line and then press Enter soft key.
3. Press ◀ or ▶, or the Switch soft key to select Enabled from the Send Anonymous field.
4. (Optional.) Press ◀ or ▶, or the Switch soft key to select the desired value from the Anonymous Code field.
5. (Optional.) Enter the anonymous call on code in the On Code field.
6. (Optional.) Enter the anonymous call off code in the Off Code field.

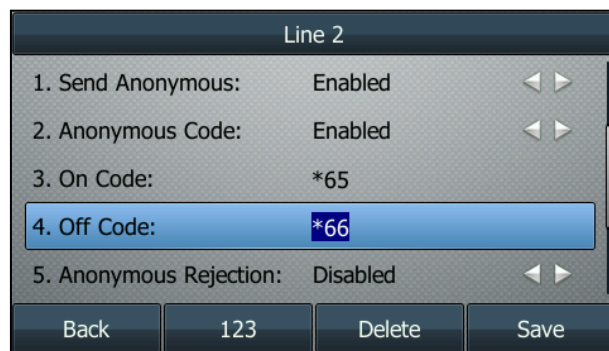

7. Press the Save soft key to accept the change or the Back soft key to cancel.

Anonymous call is configurable via web user interface at the path Account->Basic.

To place an anonymous call:

1. Using the specific line on the phone to place a call to phone B.

The LCD screen of phone B prompts an incoming call from anonymity.



Anonymous Call Rejection

You can use anonymous call rejection to reject incoming calls from anonymous callers. Anonymous call rejection automatically rejects incoming calls from callers who deliberately block their identities and numbers from showing up. Anonymous call rejection is configurable on a per-line basis.

To configure anonymous call rejection via phone user interface:

1. Press Menu->Call Features->Anonymous.
2. Select the desired line and then press Enter soft key.
3. Press or to scroll to the Anonymous Rejection field.
4. Press or , or the Switch soft key to select Enabled from the Anonymous Rejection field.
5. (Optional.) Enter the anonymous call rejection on code in the On Code field.
6. (Optional.) Enter the anonymous call rejection off code in the Off Code field.

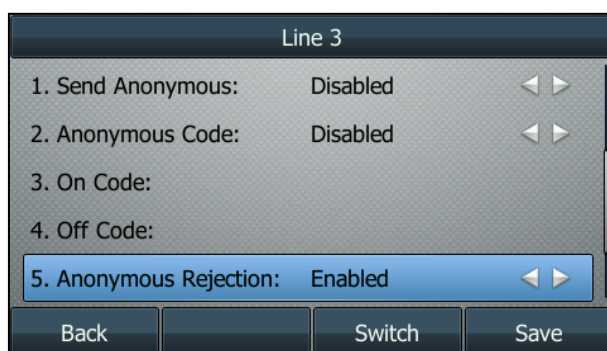

7. Press the Save soft key to accept the change or the Back soft key to cancel.

Anonymous call rejection is configurable via web user interface at the path Account->Basic.

Advanced Phone Features

This chapter provides operating instructions for the advanced features of the Commander Office T46G IP phone. Topics include:

- [Busy Lamp Field \(BLF\)](#)
- [Call Recording](#)
- [Hot Desking](#)
- [Intercom](#)
- [Multicast Paging](#)
- [Music on Hold](#)
- [Automatic Call Distribution \(ACD\)](#)
- [Messages](#)





If you require additional information or assistance with your new phone, contact your system administrator.

Busy Lamp Field (BLF)

You can use BLF to monitor a specific line for status changes on the phone. For example, you can configure a BLF key on the phone for monitoring the status of a friend's line (busy or idle). The BLF key LED illuminates solid red when the friend's line is in use. For more information on BLF key LED indications, refer to [LED Instructions](#) on page 5.

You can press a BLF key to dial out the monitored phone number when the monitored line is idle. You can receive a visual and an audio alert (if enabled), and also pick up the call when the monitored line receives an incoming call. For more information, contact your system administrator.

To configure a BLF key via phone user interface:

1. Press Menu->Call Features->DSS Keys.
2. Select the desired DSS key.
3. Press  or  , or the Switch soft key to select BLF from the Type field.
4. Press  or  or the Switch soft key to select the desired line from the Account ID field.
5. Enter the phone number or extension you want to monitor in the Value field.
6. (Optional.) Enter the string that will appear on the LCD screen in the Label field.

- (Optional.) Enter the pickup code in the Extension field.

Line Key 9	
1. Type:	BLF
2. Account ID:	Line 1
3. Label:	
4. Value:	1000
5. Extension:	*33

Back 123 Delete Save

- Press the Save soft key to accept the change or the Back soft key to cancel.

BLF key is configurable via web user interface at the path DSSKey->Line Key.

You can enable audio alert for BLF pickup on the phone. This allows the monitoring phone to play a warning tone when the monitored line receives an incoming call. You can also enable visual alert for BLF pickup on the phone. This allows the LCD screen of the monitoring phone to display the caller ID when the monitored line receives an incoming call.

To enable visual and audio alert via web user interface:

- Click on Features->Call Pickup.
- Select Enabled from the pull-down list of Visual Alert for BLF Pickup.
- Select Enabled from the pull-down list of Audio Alert for BLF Pickup.

Call Pickup

Directed Call Pickup: Disabled

Directed Call Pickup Code:

Group Call Pickup: Disabled

Group Call Pickup Code:

Visual Alert for BLF Pickup: Enabled

Audio Alert for BLF Pickup: Enabled

Confirm Cancel

- Click Confirm to accept the change.

Note

Visual and audio alerts are configurable via web user interface only.

When the monitored line receives an incoming call, the followings occur on the phone:

- The phone plays a warning tone (if enabled).

- The BLF key LED flashes red.
- The caller ID appears on the LCD screen (if enabled).

In the following figure, the LCD screen shows an incoming call from 3606 on the monitored line.

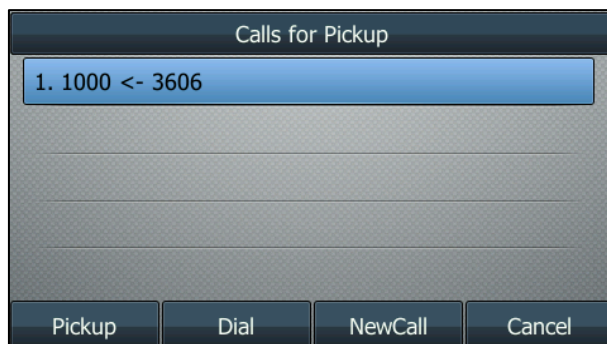

Note

If your phone is locked and the type of the keypad lock is configured as **Function Keys** or **All Keys**, you cannot use the **Pickup**, **Dial**, **NewCall** and **Cancel** soft keys until unlocked.

When there is an active call on the IP phone, you can transfer the active call to the monitored phone number directly by pressing the BLF key. The phone transfers the active call differently depending on the transfer mode via DSS key. For more information on performing call transfer, refer to [Call Transfer](#) on page 91.

To configure the transfer mode via DSS key via web user interface:

1. Click on Features->Transfer.
2. Select the desired transfer mode from the pull-down list of Transfer Mode Via Dsskey. Depending on your selection:
 - If you select Blind Transfer, press the BLF key to blind transfer the call to the monitored phone number.
 - If you select Attended Transfer, press the BLF key to dial out the monitored phone number. Then you can perform the attended or semi-attended transfer.

- If you select New Call, press the BLF key to place a new call to the monitored user.

3. Click Confirm to accept the change.

Note Transfer mode via DSS key is configurable via web user interface only.

Call Recording

You can record calls by pressing a record key on the phone. The Commander Office T46G IP phone supports record and URL record.

Two ways of call recording:

- Record: The phone sends SIP INFO message containing a specific header "Record: on/off" to trigger a recording.
- URL Record: The phone sends HTTP URL request to trigger a recording. Contact your system administrator for the predefined URL.

Note Call record is not available on all servers. Contact your system administrator for more information.

To configure a record key via phone user interface:

1. Press Menu->Call Features->DSS Keys.
2. Select the desired DSS key.
3. Press ◀ or ▶, or the Switch soft key to select Key Event from the Type field.
4. Press ◀ or ▶, or the Switch soft key to select Record from the Key Event field.

- (Optional.) Enter a string that will appear on the LCD screen in the Label field.

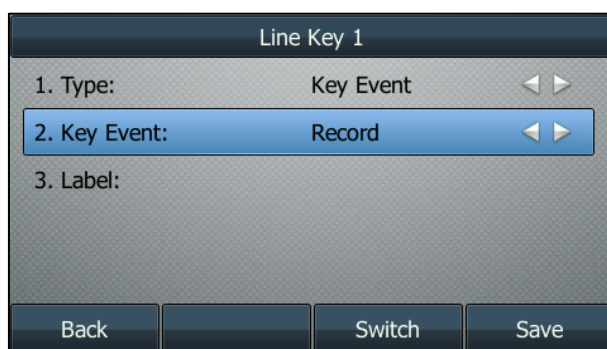

- Press the Save soft key to accept the change or the Back soft key to cancel.

To configure a URL record key via phone user interface:

- Press Menu->Call Features->DSS Keys.
- Select the desired DSS key.
- Press or , or the Switch soft key to select URL Record from the Type field.
- (Optional.) Enter a string that will appear on the LCD screen in the Label field.
- Enter the URL (e.g., <http://10.1.2.224/phonerecording.cgi>) in the URL Record field.



- Press the Save soft key to accept the change or the Back soft key to cancel.

Record and URL record key are configurable via web user interface at the path DSSKey->Line Key.

The Record and URL Record keys control the recording, and are available:

- During an active call
- When calls are on hold or mute
- During a blind or attended transfer
- During a conference call
- When the phone prompts you to answer an incoming call

The Record and URL Record keys are not available when:

- There are no connected calls on your phone
- You place a new call

To record a call:





1. Press the Record or URL Record key during a call.

If the recording starts successfully, the recording icon will appear on the LCD screen and the Record or URL Record key LED will flash green.

2. Press the Record or URL Record key again to stop recording.

The recording icon disappears from the LCD screen and the Record or URL Record key LED goes out.

Recording status indications you need to know:

Circumstance	Icons on the LCD screen
A recording is started	 appears on the LCD screen
A recording cannot be started	 appears for 1 second
A recording cannot be stopped	 appears for 1 second, then goes back
The recording box is full	 appears for 1 second
The call cannot be recorded	 appears for 1 second

You can listen to the recordings stored on your server system. For example, you can dial an access code to listen to the recordings.

Note

The way in which you listen to the recordings may be different on different servers. Contact your system administrator for more information.

Hot Desking

Hot desking originates from the definition of being the temporary physical occupant of a work station or surface by a particular employee. A primary motivation for hot desking is cost reduction. This feature is regularly used in places where not all the employees are in the office at the same time, or not in the office for very long at all, which means actual personal offices would be often vacant, consuming valuable space and resources.

You can use hot desking on the Commander Office T46G IP phone to log out of the existing accounts and then log into a new account. As a result, many users can share the phone resource in different time. To use this feature, you need to configure a hot desking key in advance.

Note

Hot desking is not available on all servers. Contact your system administrator for more information.

To configure a hot desking key via phone user interface:

1. Press Menu->Call Features->DSS Keys.
2. Select the desired DSS key.

3. Press ◀ or ▶, or the Switch soft key to select Key Event from the Type field.
4. Press ◀ or ▶, or the Switch soft key to select Hot Desking from the Key Event field.
5. (Optional.) Enter a string that will appear on the LCD screen in the Label field.

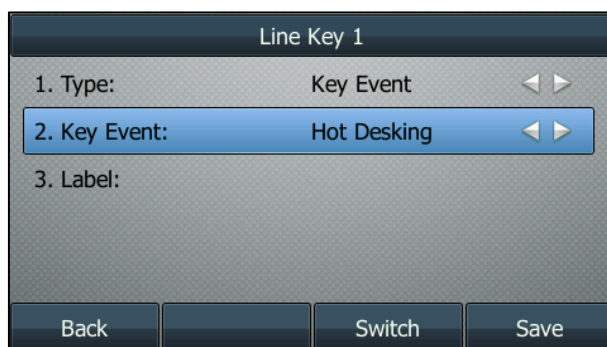

6. Press the Save soft key to accept the change or the Back soft key to cancel.

Hot desking key is configurable via web user interface at the path DSSKey->Line Key.

To use hot desking:

1. Press the hot desking key when the phone is idle.

The LCD screen prompts the following warning:

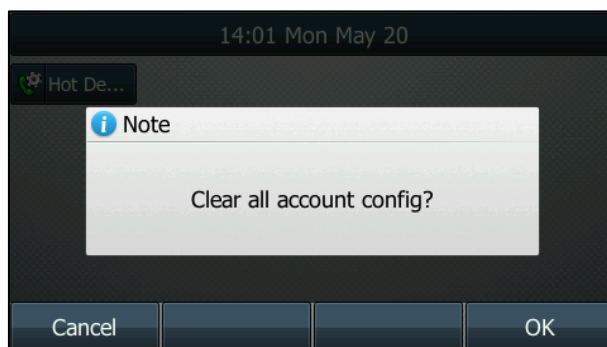

2. Press the OK soft key, registration configurations of all accounts on the phone will be cleared immediately.

The login wizard will be shown as below:

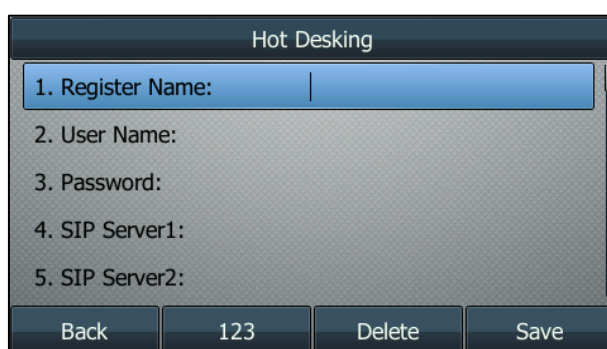

3. Enter the login information in each field.
4. Press the Save soft key to login or the Back soft key to cancel.

Intercom



Intercom is a useful feature in an office environment to quickly connect with the operator or the secretary. You can press the intercom key to automatically connect with a remote extension for outgoing intercom calls, and the remote extension will automatically answer the incoming intercom calls.

Note

Intercom is not available on all servers. Contact your system administrator for more information.

Outgoing Intercom Calls

To configure an intercom key via phone user interface:

1. Press Menu->Call Features->DSS Keys.
2. Select the desired DSS key.
3. Press  or , or the Switch soft key to select Intercom from the Type field.
4. Select the desired line from the Account ID field.
5. (Optional.) Enter the string that will appear on the LCD screen in the Label field.

- Enter the remote extension number in the Value field.

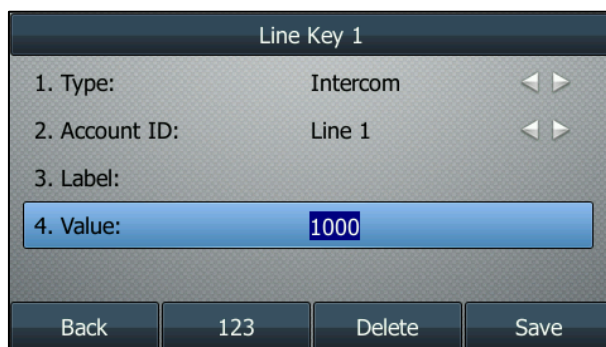

- Press the Save soft key to accept the change or the Back soft key to cancel.

Intercom key is configurable via web user interface at the path DSSKey->Line Key.

To place an intercom call:

- Press the intercom key when the phone is idle.
The phone is automatically connected to the extension specified in the Value field.
- Press the intercom key again or the Cancel soft key to end the intercom call.

Incoming Intercom Calls

The Commander Office T46G IP phone supports automatically to answer an incoming intercom call by default. The phone automatically plays a warning tone when it receives an incoming intercom call. In addition, you can enable the phone to mute the microphone when it automatically answers an incoming intercom call. You can also enable the phone to automatically answer an incoming intercom call while there is already an active call on the phone. The active call is placed on hold.

Intercom features you need to know:

Intercom Feature	Description
Accept Intercom	Enable or disable the IP phone to automatically answer an incoming intercom call.
Intercom Mute	Enable or disable the microphone on the IP phone for intercom calls.
Warning Tone	Enable or disable the IP phone to play a warning tone when it receives an incoming intercom call.
Intercom Barge	Enable or disable the IP phone to automatically answer an incoming intercom call while there is already an active call on the phone.

To configure intercom features via phone user interface:

- Press Menu->Call Features->Intercom.
- Make the desired changes.



3. Press the Save soft key to accept the change or the Back soft key to cancel.

These specific parameters are configurable via web user interface at the path Features->Intercom.

Accept Intercom

You can enable or disable the phone to automatically answer an incoming intercom call. If Accept Intercom is enabled, the phone automatically answers an incoming intercom call. If Accept Intercom is disabled, the phone rejects incoming intercom calls and sends a busy message to the caller. Accept Intercom is enabled by default.

Note

Your administrator can set a period of delay time before the phone automatically answers intercom calls. Contact your system administrator for more information.

Intercom Mute

You can mute or un-mute the microphone on the phone for intercom calls automatically. If Intercom Mute is enabled, the microphone is muted for intercom calls. If Intercom Mute is disabled, the microphone works for intercom calls. Intercom Mute is disabled by default.

Warning Tone

You can enable or disable the phone to play a warning tone when receiving an intercom call. If Warning Tone is enabled, the phone plays a warning tone before answering the intercom call. If Warning Tone is disabled, the phone automatically answers the intercom call without warning. Warning Tone is enabled by default.

Intercom Barge

You can enable or disable the phone to automatically answer an incoming intercom call while there is already an active call on the phone. If Intercom Barge is enabled, the phone automatically answers the intercom call and places the active call on hold. If Intercom Barge is disabled, the phone handles an incoming intercom call like a waiting call. Intercom Barge is disabled by default.

Multicast Paging

You can use multicast paging to quickly and easily forward time sensitive announcements out to people within the multicast group. You can configure a multicast paging key on the phone, which

allows you to send a Real Time Transport Protocol (RTP) stream to the pre-configured multicast address(es) without involving SIP signaling. You can configure the phone to receive an RTP stream from pre-configured multicast listening address(es) without involving SIP signaling. You can specify up to 10 multicast listening addresses.

Sending RTP Stream

To configure a multicast paging key via phone user interface:

1. Press Menu->Call Features->DSS Keys.
2. Select the desired DSS key.
3. Press ◀ or ▶, or the Switch soft key to select Key Event from the Type field.
4. Press ◀ or ▶, or the Switch soft key to select Multicast Paging from the Key Event field.
5. (Optional.) Enter the string that will appear on the LCD screen in the Label field.
6. Enter the multicast IP address and port number (e.g., 224.5.6.20:10008) in the Value field.

The valid multicast IP addresses range from 224.0.0.0 to 239.255.255.255.

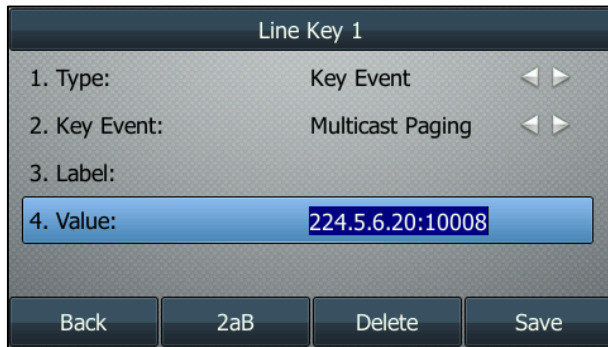

7. Press the Save soft key to accept the change or the Back soft key to cancel.

Multicast paging key is configurable via web user interface at the path DSSKey->Line Key.

You can also configure the phone to use a default codec for sending multicast RTP stream via web user interface.

To configure a default codec for multicast paging via web user interface:

1. Click on Features->General Information.
2. Select the desired codec from the pull-down list of Multicast Codec.

The default codec is G722.

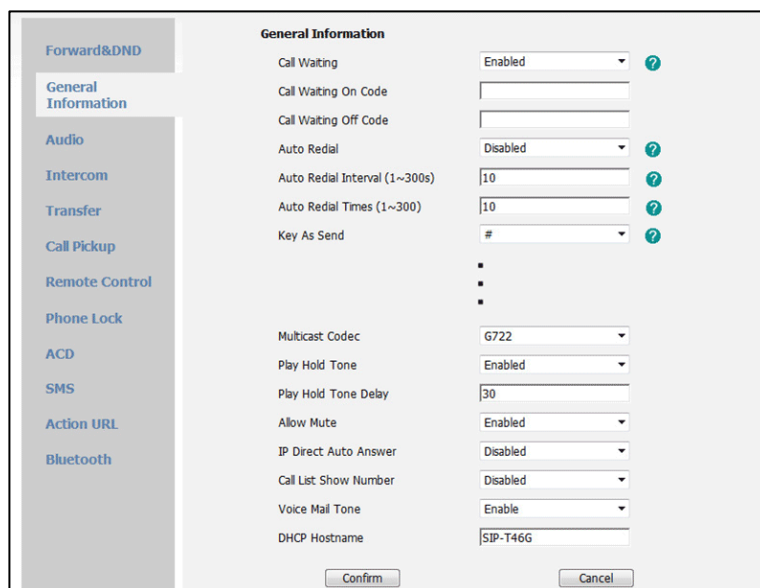

3. Click Confirm to accept the change.

Note

If G722 codec is used for multicast paging, the LCD screen displays the icon **HD** to indicate that is providing high definition voice.

Default codec for multicast paging is configurable via web user interface only.

To send RTP stream:

1. Press the multicast paging key when the phone is idle.

The phone sends RTP to a preconfigured multicast address (IP: Port). Any phone in the local network then listens to the RTP on the preconfigured multicast address (IP: Port). For both sending and receiving of the multicast RTP, there is no SIP signaling involved.

The multicast paging key LED illuminates solid green.

The following figure shows a multicast RTP session on the phone:



2. Press the Hold soft key to place the current multicast RTP session on hold.
3. Press the End Call soft key to cancel the multicast RTP session.

Note

Multicast RTP is one way only from sender to the multicast address(es) (receiver). For outgoing RTP multicasts, all other existing calls on the phone will be placed on hold.

Receiving RTP Stream

You can configure the phone to receive a Real Time Transport Protocol (RTP) stream from the pre-configured multicast address(es) without involving SIP signaling. You can specify up to 10 multicast addresses that the phone listens to on the network.

How the phone handles incoming multicast paging calls depends on Paging Barge and Paging Priority Active parameters configured via web user interface.

Paging Barge

Paging barge parameter defines the priority of the voice call in progress. If the priority of an incoming multicast paging call is lower than that of the active call, it will be ignored automatically. If Disabled is selected from the pull-down list of Paging Barge, the voice call in progress takes precedence over all incoming multicast paging calls. Valid values in the Paging Barge field:

- 1 to 10: Define the priority of the active call, 1 with the highest priority, 10 with the lowest.
- Disabled: The voice call in progress shall take precedence over all incoming paging calls.

Paging Priority Active

Paging priority active parameter decides how the phone handles incoming multicast paging calls when there is already a multicast paging call on the phone. If enabled, the phone will ignore incoming multicast paging calls with lower priorities, otherwise, the phone will answer incoming multicast paging calls automatically and place the previous multicast paging call on hold. If disabled, the phone will automatically ignore all incoming multicast paging calls.

To configure multicast listening addresses via web user interface:

1. Click on Directory->Multicast IP.
2. Select the desired value from the pull-down list of Paging Barge.
3. Select the desired value from the pull-down list of Paging Priority Active.
4. Enter the multicast IP address(es) and port number (e.g., 224.5.6.20:10008) which the phone listens for incoming RTP multicast in the Listening Address field.

- Enter the label in the Label field. Label will appear on the LCD screen when receiving the multicast RTP stream.

IP Address	Listening Address	Label	Priority
1 IP Address	224.5.6.20:10008	Paging one	1
2 IP Address			2
3 IP Address			3
4 IP Address			4
5 IP Address			5
6 IP Address			6
7 IP Address			7
8 IP Address			8
9 IP Address			9
10 IP Address			10

- Click Confirm to accept the change.

Note

The priorities of listening addresses are predefined: 1 with the highest priority, 10 with the lowest.

Both the multicast paging sender and the receiver play a warning tone when establishing a multicast paging call.

Multicast listening addresses are configurable via web user interface only.

Music on Hold

Music on hold (MoH) is the business practice of playing recorded music to fill the silence that would be heard by the party placed on hold. To use this feature, you should specify a SIP URI pointing to a Music on Hold Server account. When a call is placed on hold, the phone will send a SIP INVITE message to the Music on Hold Server account. The Music on Hold Server account automatically answers to the SIP INVITE messages and immediately plays audio from some source located anywhere (LAN, Internet) to the held party. Contact your system administrator for the SIP URI.

To configure music on hold server via web user interface:

- Click on Account.
- Select the desired account from the pull-down list of Account.
- Click on Advanced.

- Enter the SIP URI (e.g., sip:moh@sip.com) in the Music Server URI field.

The screenshot shows the 'Advanced' configuration page for 'Account 1'. The 'Music Server URI' field is set to 'sip:moh@sip.com'. Other visible settings include: Keep Alive Type (Default), Keep Alive Interval (30), Local SIP Port (5062), RPort (Disabled), SIP Session Timer T1 (0.5), SIP Session Timer T2 (4), SIP Session Timer T4 (5), Subscribe Period (1800), and DTMF Type (RFC2833). There are 'Confirm' and 'Cancel' buttons at the bottom.

- Click Confirm to accept the change.

When you have placed a call on hold, the held party can hear the music.

Note

All involved parties cannot use encrypted RTP (SRTP).
 Music on hold server is configurable via web user interface only.

Automatic Call Distribution (ACD)

ACD is often used in offices for customer service, such as call center. The ACD system handles large volumes of incoming calls from callers who have no need to talk to a specific person but who require assistance from any of multiple persons at the earliest opportunity. ACD on the Commander Office T46G IP phone allows the ACD system to distribute large volumes of incoming calls to the registered ACD users. To use this feature, you should configure an ACD key in advance.

Note

Make sure ACD is enabled on your IP phone. For more information on enabling ACD, contact your system administrator.

To configure an ACD key via phone user interface:

- Press Menu->Call Features->DSS Keys.
- Select the desired DSS key.
- Press or , or the Switch soft key to select ACD from the Type field.

- (Optional.) Enter the string that will appear on the LCD screen in the Label field.

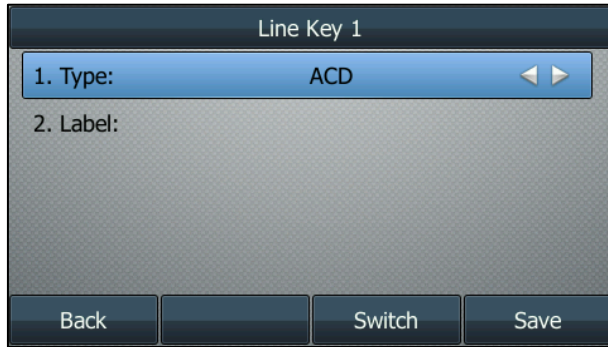

- Press the Save soft key to accept the change or the Back soft key to cancel.

ACD key is configurable via web user interface at the path DSSKey->Line Key.

To log into the ACD system:

- Press the ACD key when the phone is idle.

The LCD screen prompts you the following information:

User ID: the identity used to log into the queue.

Password: the password used to log into the queue.

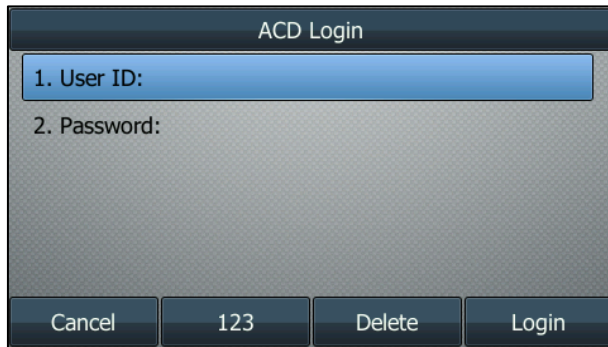

- Press the Login soft key to log into.

Note

Contact your system administrator for the User ID and Password to access the ACD system.

After configuring an ACD key, you can press the ACD key to log into the ACD system. After logging in, you are ready to receive calls from the ACD system. You can press the ACD key to show your current ACD user status. You can press the Available/Unavailable soft key to change your ACD user status. ACD user status synchronises on both IP phone and ACD system.

When you set the ACD user status to be available, the ACD key LED illuminates solid green, and then the server begins distributing calls to your phone.

When you set the ACD user status to be unavailable, the ACD key LED flashes green, and then the server temporarily stops distributing calls to your phone. To log out of the ACD system, press the Logout soft key.

Note

It is recommended you configure no more than one ACD key per phone. At any time, at most one ACD key can be in progress on your phone.

Messages

Short Message Service (SMS)

You can send and receive text messages using the Commander Office T46G IP phone. New text messages can be indicated both acoustically and visually. When receiving a new text message, the phone will play a warning tone. The power indicator LED will slow flash red, and the LCD screen will prompt receiving new text messages with the number of waiting messages (e.g., 1 New Text Message) and an icon.

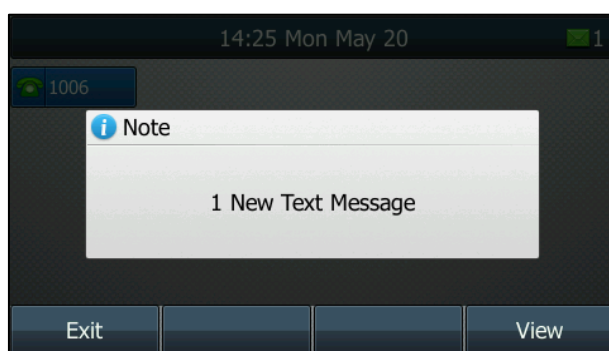

Note

SMS is not available on all servers. Contact your system administrator for more information.

To read a text message:

1. Press Menu->Messages->Text Message->Inbox.

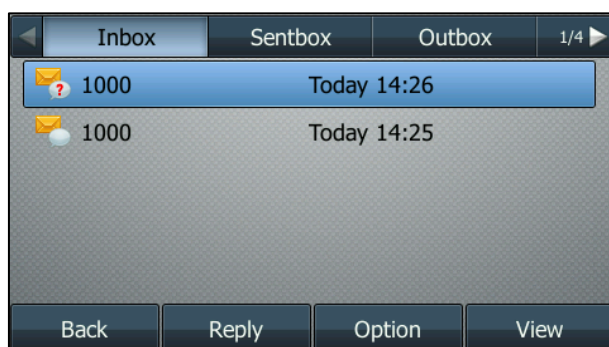

2. Select the desired message and press the View soft key.

Note

If the phone prompts receiving new text messages, you can also press the **View** soft key to read the new messages directly.

To send a text message:

1. Press Menu->Messages->Text Message->New Message.
2. Compose the new text message. You can press the abc soft key to change the input mode.
3. Press the Send soft key.
4. (Optional.) Press ◀ or ▶, or the Switch soft key to select the desired account from the From field.
5. Enter the number you want to send the message to in the To field.
6. Press the Send soft key to send the message or the Back soft key to cancel.

Sending a text message is configurable via web user interface at the path Features->SMS.

To reply a text message:

1. Press Menu->Messages->Text Message->Inbox.
2. Select the desired message and press the Reply soft key.
3. Compose the new text message. You can press the abc soft key to change the input mode.



4. Press the Send soft key after completing the content.

To delete a text message:

1. Press Menu->Messages->Text Message->Inbox (Sent Box, Outbox or Draftbox).

2. Select the desired message and then press the Option soft key.

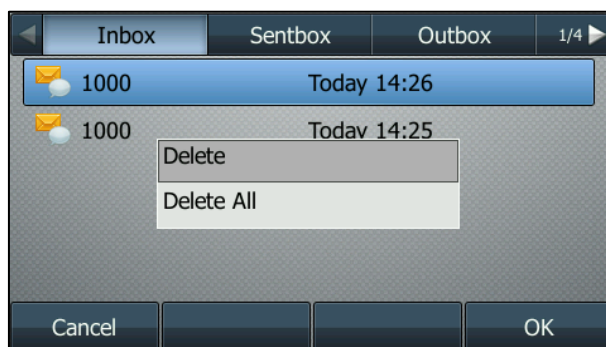

3. Select Delete to delete the desired message.
The LCD screen prompts "Delete the selected message".

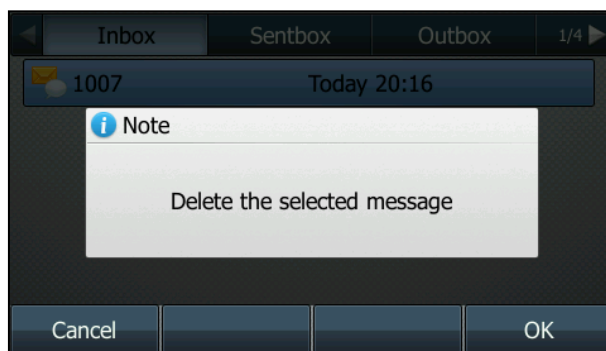

4. Press the OK soft key to delete this message or the Cancel soft key to cancel.
You can also delete all text messages by pressing the Option soft key and then select Delete All. For more information, refer to the above steps.

Note You can also delete a specific message after retrieving by pressing the **Delete** soft key.

Voice Mail

You can leave voice mails for someone else on the Commander Office T46G IP phone. You can also listen to the voice mails stored in a centralised location. When receiving a new voice mail, the phone will play a warning tone, and the power indicator LED will slow flash red. The LCD screen will prompt receiving a new voice mail with the number of waiting voice mails (e.g., New Voice Mail(1)) and an icon.

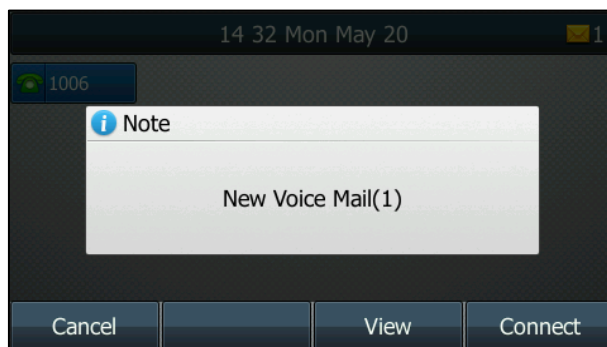

Note

Voice Mail is not available on all servers. Contact your system administrator for more information.

To leave a voice mail:

You can leave a voice mail for someone else when he/she is busy or inconvenient to answer the call. Follow the voice prompt from the system server to leave a voice mail, and then hang up.

To configure voice mail access codes via phone user interface:

1. Press Menu->Messages->Voice Mail->Set Voice Mail.
2. Press the navigation keys to highlight the account which you want to set.
3. Press the 123 soft key to select the proper input mode and then enter the voice mail access code (e.g., *97).

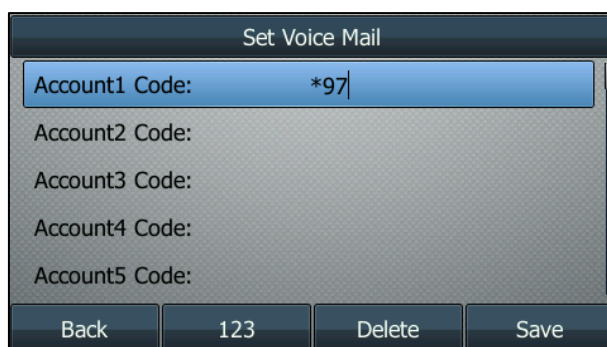

4. Press the Save soft key to accept the change or the Back soft key to cancel.

Note

Voice mail access code must be predefined on the system server. Contact your system administrator for the more information.

To listen to the voice mails:

1. When the phone user interface prompts receiving new voice mails and the power indicator LED slow flashes red, press  or the Connect soft key to dial out the voice mail access code.
2. Follow the voice prompt to listen to voice mails.

Note

Before listening to voice mails, make sure the voice mail access code has been configured.

When all new voice mails are retrieved, the power indicator LED will go out.

To view the voice mail via phone user interface:

1. Press Menu->Messages->Voice Mail->View Voice Mail.

The LCD screen displays the amount of new and old voice mails



2. Select an account and then press the Connect soft key to listen to voice mails.

Message Waiting Indicator (MWI)

The Commander Office T46G IP phone supports MWI when receiving a new voice message. If someone leaves you a voice mail, you will receive a message waiting indicator. MWI will be indicated in three ways: a warning tone, an indicator message (including a voice mail icon) on the LCD screen, and the power indicator LED slow flashes red. This will be cleared when you retrieve all voice mails or delete them.

The MWI service is unsolicited for some servers, so the Commander Office T46G IP phone only handles the MWI messages sent from the server. But for other servers, the MWI service is solicited, so the Commander Office T46G IP phone must enable subscription for MWI.

Note

MWI service is not available on all servers. Contact your system administrator for more information.

The MWI subscription parameters you need to know:

Options	Description
Subscribe for MWI	Enable or disable a subscription for MWI service.
MWI Subscription Period	Period of MWI subscription. The IP phone sends a refresh SUBSCRIBE request before initial SUBSCRIBE expiration.
Subscribe MWI to VM	Enable or disable a subscription to the voice mail number for MWI service. To use this feature, you should also configure the voice mail number.

Note

Whether the phone sends SUBSCRIBE messages for MWI service to the account or the voice number MWI service depends on the server. Contact your system administrator for more information.

To configure subscribe for MWI via web user interface

1. Click on Account.
2. Select the desired account from the pull-down list of Account.
3. Click on Advanced.
4. Select Enabled from the pull-down list of Subscribe for MWI.

- Enter the period time in the MWI Subscription Period (Seconds) field.

Register	Account	Account 1
Basic	Keep Alive Type	Default
Codec	Keep Alive Interval (Seconds)	30
Advanced	Local SIP Port	5062
	RPort	Disabled
	SIP Session Timer T1 (0.5~10s)	0.5
	SIP Session Timer T2 (2~40s)	4
	SIP Session Timer T4 (2.5~60s)	5
	Subscribe Period (Seconds)	1800
	DTMF Type	RFC2833
	DTMF Info Type	DTMF-Relay
	DTMF Payload Type(96~255)	101
	Retransmission	Disabled
	Subscribe for MWI	Enabled
	MWI Subscription Period(Seconds)	3600
	Subscribe MWI To Voice Mail	Disabled
	Voice Mail	

- Click Confirm to accept the change.

The IP phone will subscribe to the account number for MWI service by default.

To enable Subscribe MWI to Voice Mail via web user interface:

- Click on Account.
- Select the desired account from the pull-down list of Account.
- Click on Advanced.
- Select Enabled from the pull-down list of Subscribe MWI To Voice Mail.
- Enter the desired voice mail number in the Voice Mail field.

Register	Account	Account 1
Basic	Keep Alive Type	Default
Codec	Keep Alive Interval (Seconds)	30
Advanced	Local SIP Port	5062
	RPort	Disabled
	SIP Session Timer T1 (0.5~10s)	0.5
	SIP Session Timer T2 (2~40s)	4
	SIP Session Timer T4 (2.5~60s)	5
	Subscribe Period (Seconds)	1800
	DTMF Type	RFC2833
	DTMF Info Type	DTMF-Relay
	DTMF Payload Type(96~255)	101
	Retransmission	Disabled
	Subscribe for MWI	Enabled
	MWI Subscription Period(Seconds)	3600
	Subscribe MWI To Voice Mail	Enabled
	Voice Mail	1234

- Click Confirm to accept the change.

The IP phone will subscribe to the voice mail number for MWI service using Subscribe MWI to Voice Mail.

Note

MWI subscription is configurable via web user interface only.

Troubleshooting

This chapter provides general troubleshooting information to help you solve the problems you might encounter when using your Commander Office T46G IP phone.

If you require additional information or assistance with your new phone, contact your system administrator.

Why is the LCD screen blank?

- Ensure that the phone is properly plugged into a functional AC outlet.
- Ensure that the phone is plugged into a socket controlled by a switch that is on.
- If the phone is plugged into a power strip, try to plug it directly into a wall outlet instead.
- If the phone is powered from PoE, ensure you use a PoE-compliant switch or hub.

Why does the phone display "Cable Disconnected"?

- Ensure that the Ethernet cable is plugged into the Internet port on the phone and the Ethernet cable is not loose.
- Ensure that the switch or hub in your network is operational.

Why doesn't the phone display time and date correctly?

The phone is configured to obtain the time and date from the SNTP server automatically. If the phone fails to connect the SNTP server, check your network configuration or set the time and date manually.

How do I find the basic information of the IP phone?

Press the OK key when the IP phone is idle to check the basic information of the IP phone, such as IP address and firmware version. For more basic information, refer to [Phone Status](#) on page 14.

How to obtain the MAC address of a phone when the phone is not powered on?

Three ways to obtain the MAC address of a phone:

- You can ask your supplier for shipping information sheet which includes MAC addresses according to the corresponding PO (Purchase Order).
- You can find the MAC address in the label of carton box.
- You can also find the MAC address from the phone's bar code on the back of the phone.

Why can't I get a dial tone?

- Check for any loose connections and that the phone has been installed properly. For the installation instructions, refer to [Phone Installation](#) on page 11.

- Switch between the Handset, Headset (if present) or Hands-Free Speakerphone to check whether the dial tone is present for one of the audio modes.

If the dial tone exists on another audio mode, connect a different handset or headset to isolate the problem.

Why doesn't the phone ring?

Check the ringer volume on the phone. To adjust the ringer volume setting, press the Volume key when the phone is on-hook and idle. For more information, refer to [Volume](#) on page 26.

Why can't I receive calls?

- Check the SIP registration with your system administrator.
- Check that DND (Do Not Disturb) mode is deactivated on your phone. Refer to [Do Not Disturb \(DND\)](#) on page 80.
- Check that call forward is disabled on the phone. Refer to [Call Forward](#) on page 84.
- Check whether the caller number is stored in the blacklist directory. Refer to [Blacklist](#) on page 43.
- Check if you have anonymous call rejection activated on your phone.

Why is my handset not working?

Check that the handset cord is fully connected to both the handset jack on the phone and handset. Refer to [Phone Installation](#) on page 11.

Why is my headset not working?

- Check that the headset cord is fully connected to the headset jack on the phone. Refer to [Phone Installation](#) on page 11.
- Check that the headset mode is activated. Refer to [Headset Use](#) on page 48.
- Check that the headset volume is adjusted to an appropriate level. Refer to [Volume](#) on page 26.

What is the difference between user name, register name and display name?

Both user name and register name are defined by the server. A user name is used to identify the account while a register name matched with a password is used for authentication if the server requires. Display name is the caller ID that will be displayed on the callee's LCD screen. Server configuration may override the local configuration.

Why does the phone play a tone when there is a call on hold? How to disable it?

When there is a call on hold, the phone will play a hold tone every 30 seconds. Call hold tone is enabled by default. Call hold tone and the interval of playing a hold tone are configurable via web user interface only.

To configure call hold tone and call hold tone delay via web user interface:

1. Click on Features->General Information.
2. Select Enabled or Disabled from the pull-down list of Play Hold Tone.
3. Enter the desired time in the Play Hold Tone Delay field.

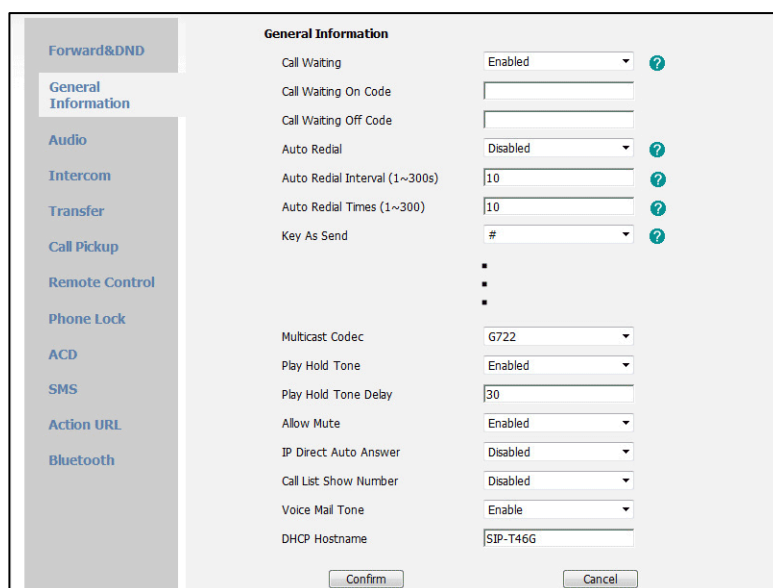

4. Click Confirm to accept the change.

Why does the wallpaper has bad display?

Do one of the following:

- Check that the custom image is clear.
- Check that the file format of the custom image for the wallpaper is .jpg, .png or .bmp.
- Check that the custom image is not too large or small. The phone will adjust the image with the short side to display.
- Check that the picture resolution of the wallpaper. The wallpaper resolution of T46G IP phone is 480*272 pixels.

Why I can't send an SMS to any other phone?

SMS depends on support from a SIP server. Contact your system administrator for more information.

How to change the user password?

To change the user password via web user interface:

1. Click on Security->Password.
2. Select user from the pull-down list of User Type.
3. Enter the new user password in the New Password field and Confirm Password field.

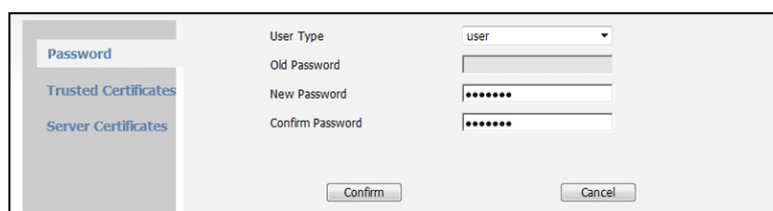

4. Click Confirm to accept the change.

You can also contact your system administrator for help.

Note

If logging into the web user interface of the phone with the user credential, you need to enter the current user password in the **Old Password** field.

User password is configurable via web user interface only.

How to reboot the phone?

To reboot the phone via web user interface:

1. Click on Settings->Upgrade.
2. Click Reboot to reboot the IP phone.

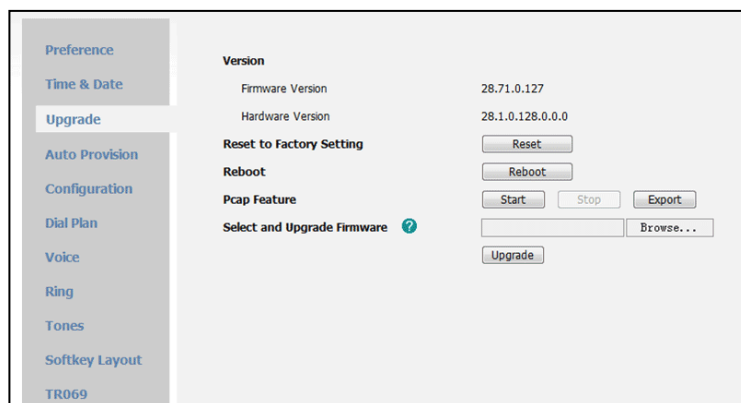

You can also long press the X key to reboot the phone directly. Any reboot of the phone may take a few minutes.

How to export PCAP trace?

We may need you to provide a PCAP trace to help analyze your problem.

To export a PCAP trace via web user interface:

1. Click on Settings->Upgrade.
2. Click Start to begin capturing signal traffic.
3. Recreate the error to be documented in the trace.
4. Click Stop to stop the capture.
5. Click Export to open file download window, and then save the file to your local system.

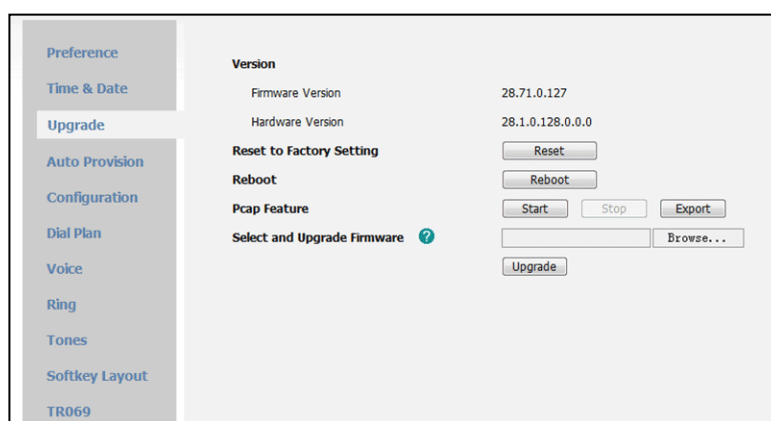

How to export system log?

We may need you to provide a system log to help analyze your problem.

To export the system log to local PC via web user interface:

1. Click on Settings->Configuration.
2. Select 6 from the pull-down list of System Log Level.
3. Click Confirm to accept the change.

The web user interface prompts "Do you want to restart your machine?". The configuration will take effect after reboot.

4. Click OK to reboot the phone.

After the IP phone finishes reboot, the system log level is set as 6, the debug level.

5. Mark the Local radio box in the Export System Log field.

- Click Export to open file download window, and then save the file to your local system.

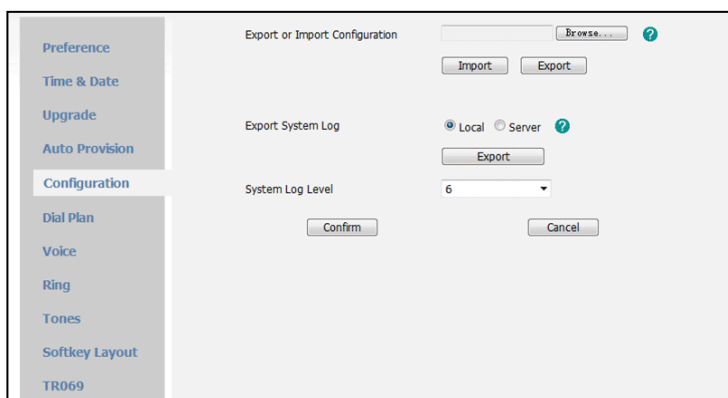

You can also export the system log to a syslog server, contact your system administrator for more information.

How to export/import the phone configurations?

We may need you to provide the phone configurations to help analyze problem. In some instance, you may need to import configurations to your phone.

To export the phone configurations via web user interface:

- Click on Settings->Configuration.
- Click Export to open file download window, and then save the file to your local system.

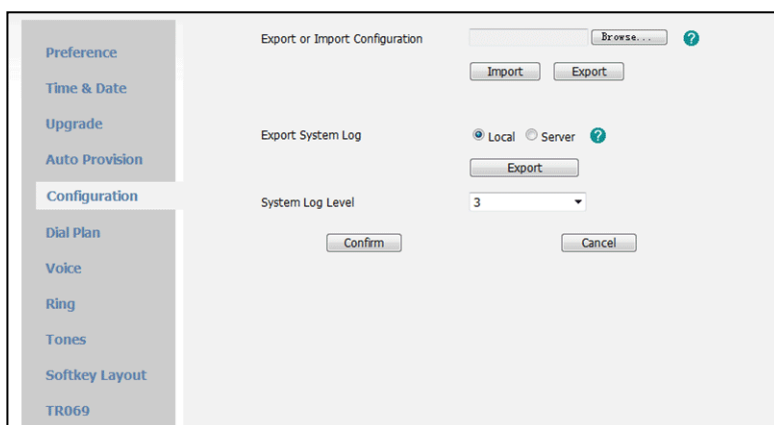

To import the phone configurations via web user interface:

- Click on Settings->Configuration.
- Click Browse to locate a configuration file from your local system.

3. Click Import to import the configuration file.

Note

The file format of configuration file must be .bin.

How to reset the phone?

Reset the phone to factory configurations after you have tried almost all troubleshooting suggestions but do not solve the problem. You need to note that all customised settings will be overwritten after reset.

To reset the phone via phone user interface:

1. Press and hold the 'OK' button on the phones keypad until you are asked if you want to Reset to factory.

The LCD screen prompts the following warning:

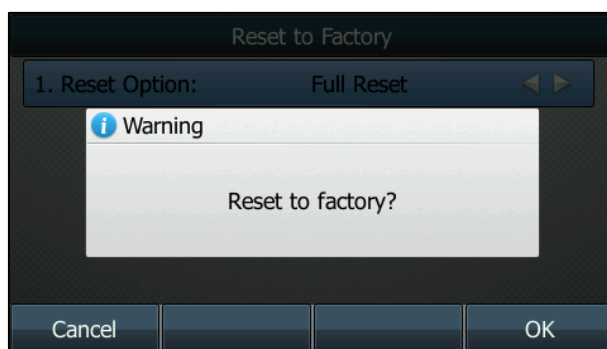

2. Press the OK soft key.

The LCD screen prompts "Welcom Initializing...Please wait".

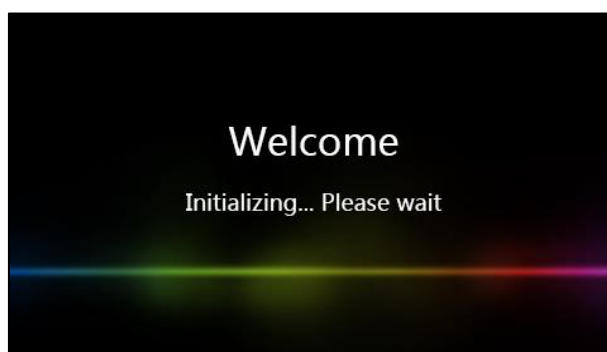

The phone will be reset to factory sucessfully after startup.

Note

Reset of the phone may take a few minutes. Do not power off until the phone starts up successfully.

Regulatory Notices

Service Agreements

Contact your Commander Authorised Reseller for information about service agreements applicable to your product.

Limitations of Liability

TO THE FULL EXTENT ALLOWED BY LAW, COMMANDER EXCLUDES FOR ITSELF AND ITS SUPPLIERS ANY LIABILITY, WHETHER BASED IN CONTRACT OR TORT (INCLUDING NEGLIGENCE), FOR INCIDENTAL, CONSEQUENTIAL, INDIRECT, SPECIAL, OR PUNITIVE DAMAGES OF ANY KIND, OR FOR LOSS OF REVENUE OR PROFITS, LOSS OF BUSINESS, LOSS OF INFORMATION OR DATA, OR OTHER FINANCIAL LOSS ARISING OUT OF OR IN CONNECTION WITH THE SALE, INSTALLATION, MAINTENANCE, USE, PERFORMANCE, FAILURE, OR INTERRUPTION OF ITS PRODUCTS, EVEN IF COMMANDER OR ITS AUTHORIZED RESELLER HAS BEEN ADVISED OF THE POSSIBILITY OF SUCH DAMAGES, AND LIMITS ITS LIABILITY TO REPAIR, REPLACEMENT, OR REFUND OF THE PURCHASE PRICE PAID, AT COMMANDER'S OPTION. THIS DISCLAIMER OF LIABILITY FOR DAMAGES WILL NOT BE AFFECTED IF ANY REMEDY PROVIDED HEREIN SHALL FAIL OF ITS ESSENTIAL PURPOSE.

Safety Instructions

Save these instructions. Read these safety instructions before use!

The following basic safety precautions should always be followed to reduce risk of fire, electrical shock, and other personal injury.

General Requirements

- Before you install and use the device, read the safety instructions carefully and observe the situation during operation.
- During the process of storage, transportation, and operation, please always keep the device dry and clean.
- During the process of storage, transportation, and operation, please avoid collision and crash of the device.
- Please attempt not to dismantle the device by yourself. In case of any discrepancy, please contact the appointed maintenance center for repair.
- Without prior written consent, no organization or individual is permitted to make any change to the structure or the safety design of the device. Commander is under no circumstance liable to consequences or legal issues caused by such changes.
- Please refer to the relevant laws and statutes while using the device. Legal rights of others should be respected as well.

Environmental Requirements

- Place the device at a well-ventilated place. Do not expose the device under direct sunlight.
- Keep the device dry and free of dusts.
- Place the device on a stable and level platform.
- Please place no heavy objects on the device in case of damage and deformation caused by the heavy load.

- Keep at least 10 cm between the device and the closest object for heat dissipation.
- Do not place the device on or near any inflammable or fire-vulnerable object, such as rubber-made materials.
- Keep the device away from any heat source or bare fire, such as a candle or an electric heater.
- Keep the device away from any household appliance with strong magnetic field or electromagnetic field, such as a microwave oven or a refrigerator.

 Operating Requirements

- Do not let a child operate the device without guidance.
- Do not let a child play with the device or any accessory in case of accidental swallowing.
- Please use the accessories provided or authorised by the manufacturer only.
- The power supply of the device shall meet the requirements of the input voltage of the device. Please use the provided surge protection power socket only.
- Before plugging or unplugging any cable, make sure that your hands are completely dry.
- Do not spill liquid of any kind on the product or use the equipment near water, for example, near a bathtub, washbowl, kitchen sink, wet basement or near a swimming pool.
- Do not tread on, pull, or over-bend any cable in case of malfunction of the device.
- During a thunderstorm, stop using the device and disconnect it from the power supply. Unplug the power plug and the Asymmetric Digital Subscriber Line (ADSL) twisted pair (the radio frequency cable) to avoid lightning strike.
- If the device is left unused for a rather long time, disconnect it from the power supply and unplug the power plug.
- When there is smoke emitted from the device, or some abnormal noise or smell, disconnect the device from the power supply, and unplug the power plug immediately. Contact the specified maintenance center for repair.
- Do not insert any object into equipment slots that is not part of the product or auxiliary product.
- Before connecting a cable, connect the grounding cable of the device first. Do not disconnect the grounding cable until you disconnect all other cables.

 Cleaning Requirements

- Before cleaning the device, stop using it and disconnect it from the power supply.
- Use a piece of soft, dry and anti-static cloth to clean the device.
- Keep the power plug clean and dry. Using a dirty or wet power plug may lead to electric shock or other perils.

Index

A

About This Guide [vi](#)
 Adding Contacts [33](#)
 Anonymous Call [101](#)
 Anonymous Call Rejection [102](#)
 Answering Calls [71](#)
 Attaching Stand [11](#)
 Audio Settings [26](#)
 Auto Answer [71](#)
 Auto Redial [75](#)
 Automatic Call Distribution [117](#)

B

Backlight [17](#)
 Basic Network Settings [15](#)
 Blacklist [43](#)
 Bluetooth [50](#)
 Busy Lamp Field (BLF) [103](#)

C

Call Completion [76](#)
 Call Forward [84](#)
 Call Mute [78](#)
 Call History Management [47](#)
 Call Hold/Resume [79](#)
 Call Park [96](#)
 Call Pickup [97](#)
 Call Recording [106](#)
 Call Return [78](#)
 Call Transfer [91](#)
 Call Waiting [92](#)
 Conference [93](#)
 Contact Management [29](#)
 Contrast [18](#)
 Copyright [v](#)
 Customizing Your Phone [16](#)

D

Deleting Contacts [37](#)
 Do Not Disturb (DND) [80](#)
 Documentation [8](#)
 DSS Keys [55](#)

E

Editing Contacts [36](#)
 Emergency Number [66](#)
 Ending Calls [72](#)

G

General Settings [16](#)
 Getting Started [9](#)

H

Hardware Component Instructions [1](#)
 Headset Use [48](#)
 Headset Mode Activation/Deactivation [49](#)
 Hotline [67](#)
 Hot Desking [108](#)

I

Icon Instructions [3](#)
 Idle screen [15](#)
 Importing/Exporting Contact lists [41](#)
 In This Guide [vi](#)
 Incoming Intercom Calls [111](#)
 Intercom [110](#)

K

Keypad Lock [22](#)

L

Language [19](#)
 LED Instructions [5](#)
 Limitation of Liability [134](#)
 Line Keys [55](#)
 Local Conference [93](#)
 Local Directory [30](#)

M

Message Waiting Indicator [123](#)
 Messages [119](#)
 Multicast Paging [112](#)
 Multiple Line Keys per Account [65](#)
 Music on Hold [116](#)

N

Network Conference [94](#)
 Network Connection [11](#)

P

Packaging Contents [9](#)
 Phone Initialization [14](#)
 Phone Installation [11](#)
 Phone Status [14](#)
 Phone User Interface [6](#)
 Placing Calls [69](#)
 Placing Calls to Contacts [39](#)
 Programmable Keys [65](#)

O

Outgoing Intercom Calls [110](#)
 Overview [1](#)

R

Recent Call In Dialing [73](#)
Redialing Numbers [73](#)
Regulatory Notices [134](#)
Remote Phone Book [45](#)
Ring Tones [27](#)

S

Safety Instructions [134](#)
Search Source List in Dialing [40](#)
Searching for Contacts [39](#)
Semi-attended Transfer [91](#)
Service Agreements [134](#)
Short Message Service (SMS) [119](#)
System Customizations [48](#)

T

Time & Date [20](#)
Troubleshooting [127](#)

V

Voice Mail [122](#)
Volume [26](#)

W

Wallpaper [16](#)
Web User Interface [6](#)